

PYLE

PyleUSA.com



PBT97

4 Way Stereo Car Music Streaming
Car Music Transmitter with Built-in BT
for Wireless Music Streaming

USER GUIDE

BRIEF INTRODUCTION

This device streams music and calls directly from your Wireless BT device to your car FM stereo system. The detachable designed microphone provides you with an amazing hands-free function, and it is also with a Micro SD Memory Card/USB Disk slot that lets you enjoy favorite MP3 and WMA tunes by your car's stereo system. Please read the User Manual carefully before using. Hope this device makes your driving more interesting and safer.

COMPATIBILITY

This device can be paired as a hands free kit with any compatible Wireless BT 2.1 or higher enabled devices.

Note:

The main body of the product can be used independently, but with the detachable microphone, you can enjoy clearer sound quality in talking while driving.

PRECAUTIONS

Please read all safety instruction warnings carefully before using this product. Improper use of this product may result in damage to this or attached products. To ensure the products work well, please never use this in the following conditions:

1. Moist or underwater conditions.
2. Conditions near heater or high-temperature service.
3. Conditions with direct and strong sunshine,
4. Conditions with apt falling
5. Never dismantle the product without due permission, otherwise it may nullify the warranty clause.

PRODUCT OVERVIEW

Fig. 1

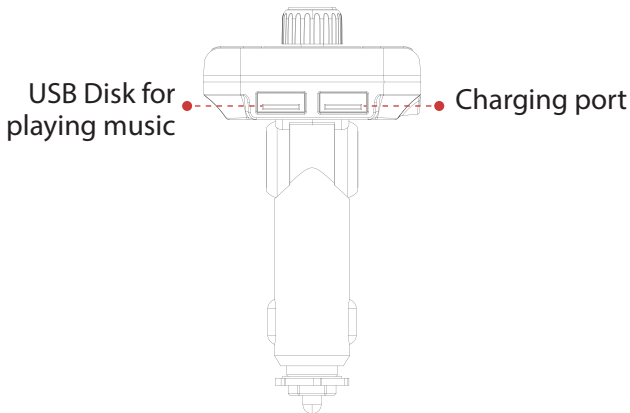
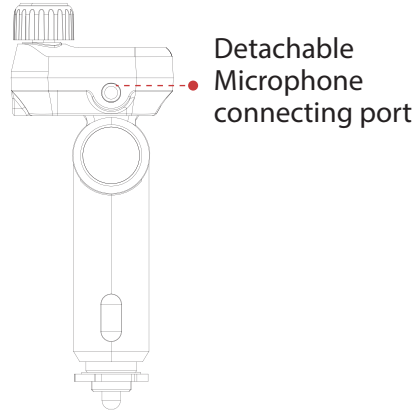
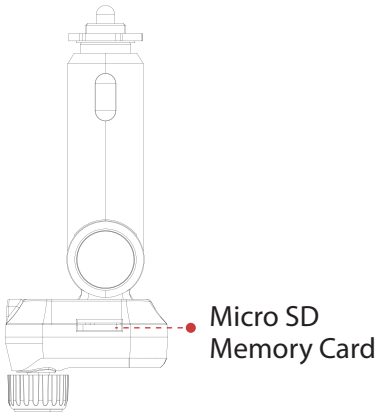
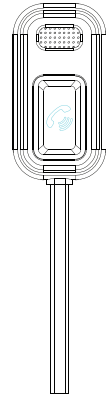
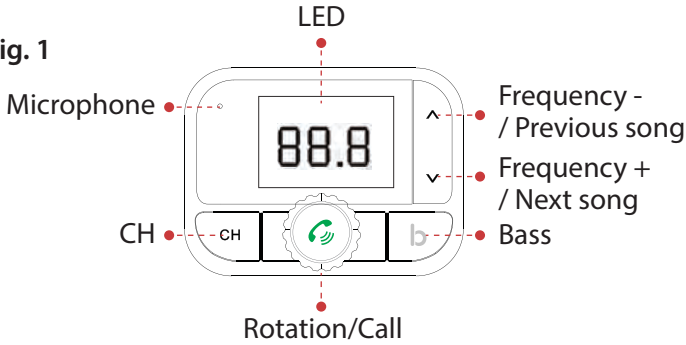

OPERATION INSTRUCTIONS

Setup the FM Transmitter Connection:

1. Plug the unit into your vehicle's cigarette lighter or power port.
2. Tune your radio to an unused FM frequency, then match the same frequency of this unit.

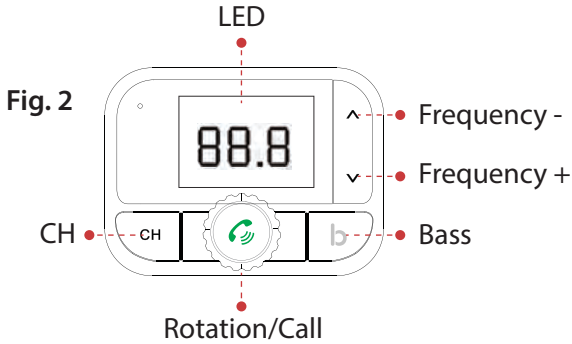

(Follow Fig.2 as follow to adjust the frequency of units)

3. Insert Micro SD Memory Card or USB disk which containing MP3/WMA files into the card/USB slot. It will play and transmit the file automatically.

Fig. 3

Micro SD Memory Card

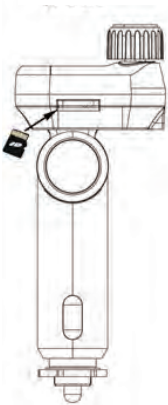

Play/Pause

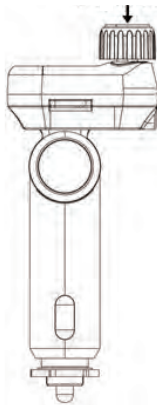

Volume-

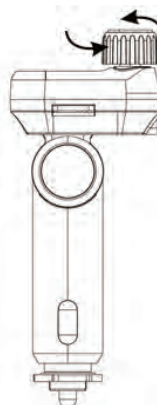

Volume+

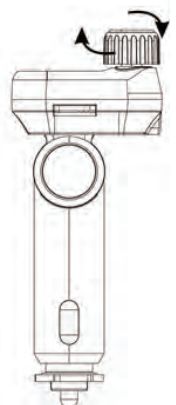

(Follow the Fig. 3 as below to control your music easily.)

Note:

Press \wedge or \vee to select a song;
 Rotate the knob to adjust the volume.

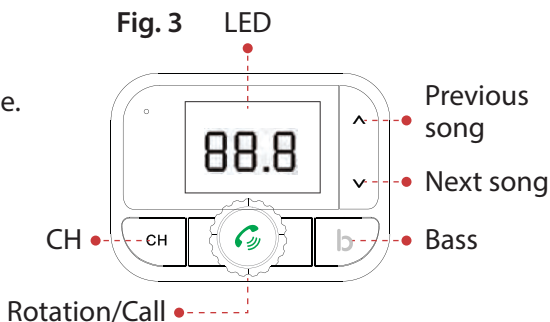







- 4. Detachable Microphone:** After the device was powered on and paired by Wireless BT, plug the provided detachable microphone into the main unit's 3.5mm port, and fix the microphone on the car dash board by provided 3M tape, then you can enjoy clearer sound quality in talking while driving. The main unit can also be used independently without the detachable microphone.
- 5.** During Music playing mode, press "b" button can activate the high quality sound.

USING WIRELESS BT STREAMING FUNCTION

- Using Wireless BT for the first time, you need to pair your mobile phone with this unit. Activate your mobile phone's Wireless BT function, then search new device. When the mobile phone detects this unit (named as "PyleUSA PBT97"), normally the connection will be built-up automatically and doesn't request a password, but if there is a need (special design of some cell phones), please use the password "0000".
- In the music playing mode, when there is an incoming call, this unit will automatically switch to telephone mode. When you pause the music after 10s, the music source will automatically switch to USB disk or Micro SD Memory Card.

WIRELESS BT CALLING

- Press  to answer the incoming call, press and hold  for 3 seconds to reject the incoming call.
- Press  to hang off a call.
- Press  twice to dial the last number automatically, press  again to cancel the current dialing.
- During a call, press and hold  for 3 seconds to switch to private conversation.

Note: The button  on the main unit and on the detachable microphone has same function in talking aspect.

FEATURES:

- Portable Car Music Transmitter
- 4 Way Stereo Music Streaming
- Wireless Phone Call & Audio Streaming Transmitter
- Automatic Hands-Free Mode
- Built-in FM Transmitter
- Hassle-free Design & Simple Plug-in Operation
- 4 Way Stereo Music Streaming
- LCD Backlight Display Screen
- Incorporated Voice Microphone Cable
- Detect and Display the Voltage of the Car Battery When Powered On
- Full 206 Channels Optional From 87.5-108 MHz
- Support Micro SD Card & Read USB Disk
- Quick Siri/Google Assistant Activation
- User-friendly Switch to Private Call
- Hook and Loop Fastener
- Micro SD Memory Card Slot

WIRELESS BT STREAMING:

- Built-in BT for Wireless Music Streaming
- Built-in Microphone for Hands-Free Calling
- Compatible with All of Your Favorite Wireless BT Devices
(iPhone, Androids, Smartphones, iPad, Tablets, etc.)
- Wireless BT Version: 5.0
- Wireless Range: Up to 30'+ ft.

WHAT'S IN THE BOX:

- Wireless BT device
- User Guide
- Detachable microphone
- Hook and loop fastener



TECHNICAL SPECS:

- Frequency Range: 87.5-108.0MHz
- Digital Media File Compatibility: MP3 WMA
- Maximum USB/SD Memory Card Support Size: 64GB
- Total output: 5V/3.4A, 2.4A, and 1A&USB reading
- FM Transmitter Size: 2.32" x 1.73" x 4.33" - inches
- Microphone Size: 1.5 x 0.79" x 0.35" – inches
- Length of Cable: 23.62" - inches



WARNING:

This product can expose you to a chemical or group of chemicals, which may include "Cadmium (Cd)" which is known in the state of California to cause cancer, birth defects, or other reproductive harm. For more info, go to <https://www.p65warnings.ca.gov/>.

PYLE

PyleUSA.com



VISIT US ONLINE:

Have a question?

Need service or repair?

Want to leave a comment?

PyleUSA.com/ContactUs

PYLE

Questions? Issues?

We are here to help!

Phone: (1) 718-535-1800

Email: support@pyleusa.com