

PDWM811RD - PDWM812WH - PDWM813BK

UHF 2 Channel Wireless Handheld Microphone

Portable Digital Audio Sound Mixer Receiver Set
with Bluetooth Receiver System, Addressable Frequency

USER GUIDE

PYLE
PyleUSA.com

WIRELESS HANDHELD MICROPHONE SYSTEM SPECIFICATION

Please read carefully before use and keep for future reference.

TRANSMITTER

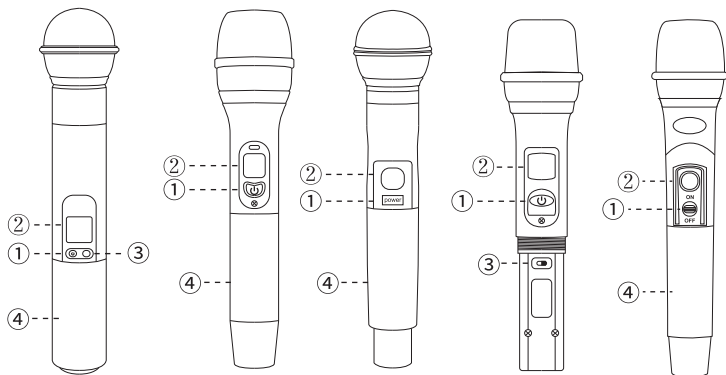

1. Power switch
2. Display screen
3. Frequency selective buttons
4. Battery case

Questions? Comments?

We are here to help!

Phone: (1) 718-535-1800

Email: support@pyleusa.com

RECEIVER

Front Panel

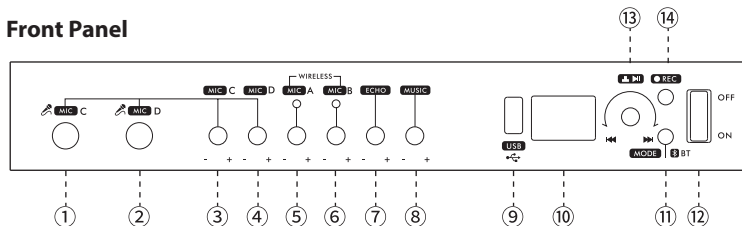

1. Mic C/6.35 Input port
2. Mic D/6.35 Input port
3. Volume adjustment for channel C
4. Volume adjustment for channel D
5. Volume adjustment for channel A
6. Volume adjustment for channel B
7. Echo adjustment
8. Music Volume adjustment
9. USB 2.1 input port
10. MP3 module display
11. Switch button (Bluetooth/MP3)
12. Power switch
13. Multi function button
(Pause/Play/Next/Last)
14. Recording Button

Back Panel

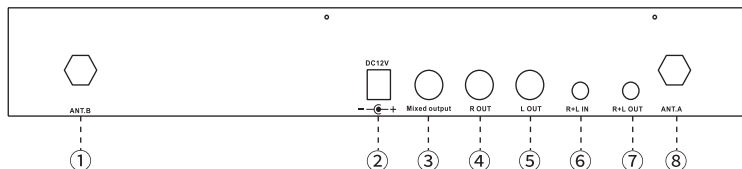

1. Antenna for B channel
2. DC12V Power supply
3. 6.35 Mixed output port
4. Right channel 6.35 output port
5. The left Channel 6.35 output port
6. Stereo 3.5mm Audio input port
7. Stereo 3.5mm Audio output port
8. Antenna for A channel

OPERATING THE TRANSMITTER

1. Open the battery case according to the instruction and insert battery noting correct polarities (+ and -) indicated in the battery compartment.
2. Set the handheld switch to "ON" position, or press the switch. The microphone will display the frequency which means the microphone is turned ON. Turn the switch to "OFF" for turn off power or press the switch again. If there's no frequency display that means the microphone is turned OFF.

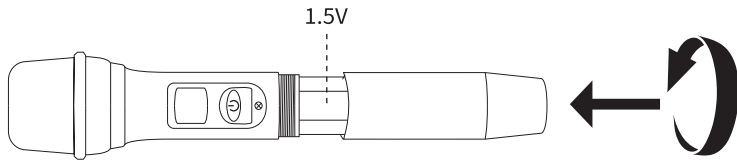

DISPLAY FUNCTION

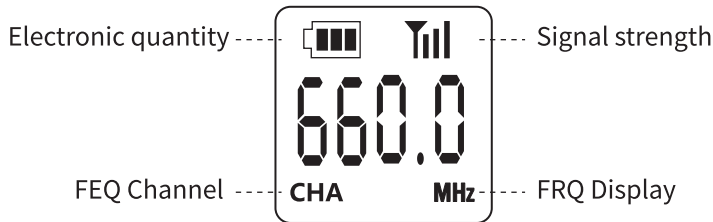

NOTE:

The receiver and transmitter system should be with same channel (frequency) one by one, otherwise it will not work.

OPERATING THE RECEIVER

1. Rotate the antennas A and B to separate them by 90 degrees.
2. Connect the power base DC/AC
3. **Audio output connection:**
 - *Mixed non-equilibrium output, insert the end of audio cable to UN BAL AF OUT: 1:2 socket and insert to the other end of MIC IN or AUX IN socket from mixer or amplifier.
4. Turn **ON** the power switch, power indicator lights up.
5. When the handheld microphone is turned on, the "RF" indicator of the receiver lights up. Receiver output volume can be controlled by the volume control knob.

***Insert the voice line into UN BAL AF OUT:** socket 1, connect the other end into socket of MIC IN or AUX IN of mixer or amplifier, same operation type with another channel.

***Independent balanced output BAL AF OUT:** 1 and 2 provide audio transmission three-pin card interface for professional mixer, amplifiers.

RECEIVER INSTALLATION THE METHOD

- One meter above the ground.
- Pull out all the antennas, otherwise it will affect the reception effect.
- Be more than one meter away from the wall.

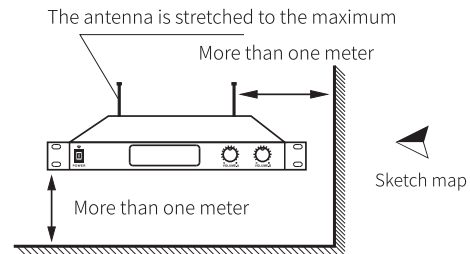

NOTICE

1. Frequency Conversion:

If you want to change the frequency during use, briefly press the frequency conversion key once.

The handheld microphone display flashes once, indicating that the frequency has been changed.

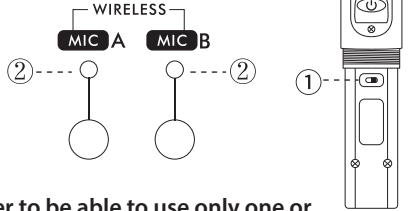

2. Frequency Lock:

In use, if you want the receiver to be able to use only one or specified Handheld microphone, please turn off the handheld microphone, and then do the following:

- Press the power switch to "ON" position, display **2** is lit, the receiver works normally.
- Press power switch **4** once, screen **6** brightness, microphone works normally
- Turn off the handheld microphone, press and hold the frequency selection button **3**, then press and hold the power switch **4** (about 5 seconds) until there is four horizontal (as shown in photo 6). On **5**, release your hand and wait for 8 seconds, "RF" indicator turns off. **5** will turn off then automatically lights up, frequency lock operation completed.

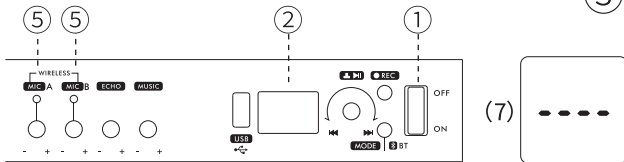

If the handheld is a toggle switch, just press the frequency conversion button for three seconds to lock the frequency.

Note: To release the locking function, repeat the above operation.

PRECAUTIONS FOR USE

1. To ensure the receiving performance, avoid placing the host unit on the dead corner.
2. Do not throw the handheld microphone to avoid serious damage.
3. The machine body is not waterproof, please avoid water droplets or rain from entering the machine body.
4. Keep away from the electromagnetic field, high-voltage transmission networks and large metal objects as far as possible.
5. Do not disassemble by yourself. The internal voltage may cause an electric shock to you.
6. When replacing the battery, be sure to press and hold the power button on the microphone until the screen turns off.
7. If the microphone is not used for a long time, please take out the battery to prevent battery leakage.
8. If the receiver is not used for a long time, please unplug the AC power plug.
9. If the machine falls apart or foreign matters enter the machine, do not continue to use it. Contact the local dealer or recognized service center immediately. Do not disassemble and repair by yourself. There is high voltage in the machine, which may cause you the risk of electric shock.
10. Keep the power adapter easy to operate. If the power adapter is not used for a long time, please unplug the AC power plug.
11. In order to protect the environment, please put the waste battery into the designated classified trash can or return it to the manufacturer. It can not be discarded directly. Do not put the battery or battery pack in the sun, fire baking, and other similar overheated environments.

NOTE: Make sure that the volume control is set to minimum position before power is switched on. Loud noise produced at high volume when power is switched on can impair hearing.

BLUETOOTH FUNCTION

1. When the receiver is turned on, the Bluetooth function is automatically turned on.
2. Turn on Bluetooth on your mobile phone, and search the Bluetooth name 'PYLEUSA', click and pair.
3. Bluetooth and handheld input will be synchronized.
 - Wireless BT Version: 4.2
 - Wireless BT Range: 32' ft

NOTICE:

All Pictures shown are for illustration purpose only. Actual product may vary due to product enhancement. *Pictures shown are for illustration purpose only.

FEATURES:

- Hassle-Free Wireless Microphone System
- Multi-Source Audio Signal Mixing Ability
- Control Audio Levels from External Devices
- Wireless BT Music Streaming Ability
- Dual Fixed Frequency System Design
- Adjustable Rotary Controls: Echo, Tone, Volume: Mic 1, Mic 2
- Wired Microphone Support (2) 1/4" Mic Inputs
- (2) 1/4" Mic Inputs
- RCA Audio (L/R) Input/Output Jacks
- Rear Panel 1/4" Mixed Output
- Adjustable Antennas for Extended Wireless Range
- Includes Handheld Wireless Microphones
- Rugged Microphone Construction & Steel Mesh Grill
- Convenient ON/OFF/MUTE Power Switch
- Battery Operated Mic, Requires (2) 'AA' Batteries, Included
- Ultra-Wide Frequency Range
- Ideal for speech, Karaoke, DJ Sound & House Party Audio

WHAT'S IN THE BOX:

- (2) Handheld Microphone
- (1) 3.5 Double Lotus Conversion Cable, 59.1" -inches
- (1) 6.35 to XLR Male, 118" -inches
- (2) Four Corner Ring
- (4) No. 3 1.5V AA Battery
- (1) Two Ends of 6.35 through the Machine Line, 39.4" -inches
- (1) Dual Channel Cable, 59.1" -inches
- (1) Two-pin (UL) Flat Plug Power Cord

TECHNICAL SPECS:

- UHF Addressable Frequency: 510-590MHz
- Wireless Operation Range: Up to 165'+ ft.
- Modulation Mode: FM
- Maximum Deviation: +/-75KHz
- Frequency Response: 80-18kHz (+/-3dB)
- Frequency Stability: 20ppm
- Audio Dynamic Range: >90dB
- S/N Ratio: >95dB
- T.H.D: <0.5%
- Mirror Image Rejection: >50dB
- LINE Input Sensitivity: 380mV/-8.5dB
- MIC Input Sensitivity: 5mV/-46dB
- LINE Input Impedance: 20 K Ω
- MIC Input Impedance: 600 Ω
- Receiver Power Supply: 120/240V (18V/500mA Power Adapter)
- Mic Element: Dynamic
- Antenna: Built-in Housing
- RF Output: <10mW
- Spurious Emission: <-40dB
- Battery Operated Mic, requires (2) 'AA' Batteries Each
- Current Dissipation: <140mA
- Microphone Dimensions (L x D): 9.65" x 9.45" -inches
- Base Receiver Dimensions (L x W x H): 11.8" x 3.8" x 1.8" -inches