

IMPORTANT: Pack carefully in original carton if possible. We are not responsible for damage incurred in returning items for repair. A letter stating your exact street address, daytime phone number and the problem you are experiencing should be included. You must also enclose a copy of the original receipt as proof of purchase's date

# PYLE<sup>®</sup> CYCLE SERIES

1600 63RD Street • Brooklyn • NY • 11204  
718 535-1800 • 800 444-5671  
Fax: 718 236-2400  
[www.pyleaudio.com](http://www.pyleaudio.com)

# PYLE<sup>®</sup> CYCLE SERIES

## PLMCA40



100 Watts Motorcycle/ATV/Snowmobile Mount MP3/Ipod  
USB Amplifier with Dual handle-bar Mount Weatherproof speakers W/FM Radio

## USER'S MANUAL

**CONTENTS**

AMPLIFIER-----1PC  
 LOUDSPEAKER-----2PCS  
 WIRELESS REMOTE CONTROL-----1PC  
 POWER CABLE-----1PC  
 AUDIO CABLE-----1PC  
 SPEAKER MOUNTING PLATE-----1PC  
 SCREW KIT-----1PC  
 USER'S MANUAL-----1PC



**SPECIFICATION**

RMS POWER:

25W×2@4 Ohm 10%THD

50W×2@2 Ohm 10%THD

FREQUENCY RESPONSE: 20Hz-20KHz

S/N: >50dB

CHANNEL CLACCE: <2dB

FM FREQUENCY RANGE: 87.5-108.0MHz

FM SENSITIVITY: 10µV @S/N 30Db

USB PORT: SUPPORT USB 2.0

SD SLOT: SUPPORT 128MB,256MB,512MB,1GB,2GB/4GB

**Motorcycle & Boat Stereo Audio System**

**User's Manual**

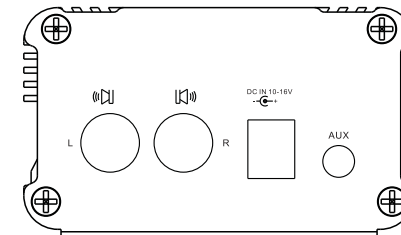
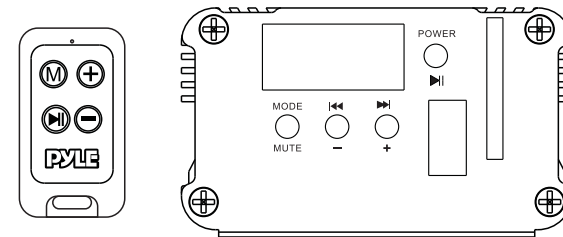

Model: PLMCA40

## Motorcycle and Boat Audio Stereo System with FM Auto Scan Radio/USB Port/ SD Slot/Aux Input

### Features

- FM Radio/AUX
- Built in FM Radio Electric Auto-scan Tuning
- Up/Down Auto-scan Tuning System
- FM Coverage:87.5-108.0MHZ
- Dot Matrix LCD FM Frequency
- Volume/Digital Control /POWER Switch/Mute Function
- 3.5mm Stereo Input Jack ,Easy Connection to the Output of Other Audio Devices Like CD/MD/Mp3/Ipod,etc
- Wireless Remote Control
- Mini Amplifier Suitable for 12 Volts Motorcycles/Scooters/Boat/ snowmobile/ATV/Waverunner
- 50 Watts x2 @ 2 Ohm 10%THD
- Frequency Response 20Hz-20KHz
- S/N:>50dB
- 3" Dual weatherproof Speakers
- Channel Balance:<2dB
- FM Sensitivity:10uV @ S/N 30dB
- USB port: support USB Flash Memory
- SD slot: support 128MB,256MB,512MB,1GB,2GB/4GB.
- Easy Mounting Brackets and Accessories included
- Amplifier Dimensions:5.2"H X 3.15"W X 1.86"D
- Speaker Dimensions:4.8"H X 4.13"W X 4.13"D

### Loudspeaker Mounting Diagram

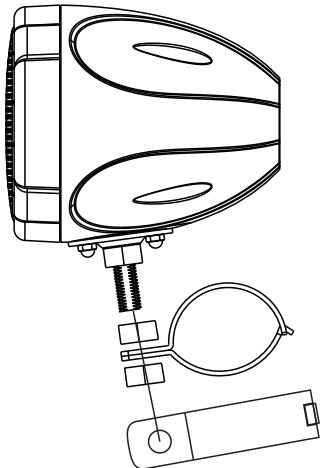

Loudspeaker mounting diagram

### Remote control

The remote control can take place of the 4 same buttons on the main unit\*.

\*Note: The key ⊕ (Power) on the remote control can't power up the system but it can power off the system.

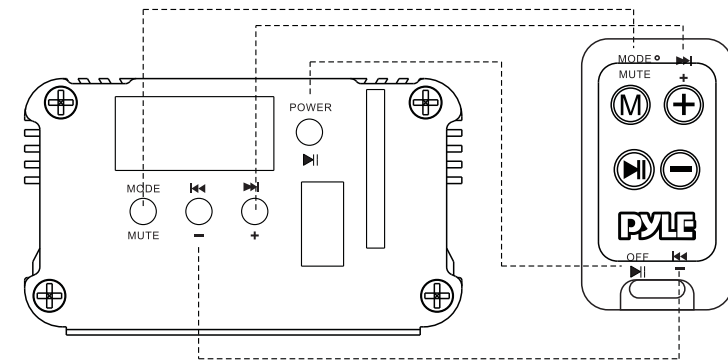

Remote control function diagram

### LCD Display

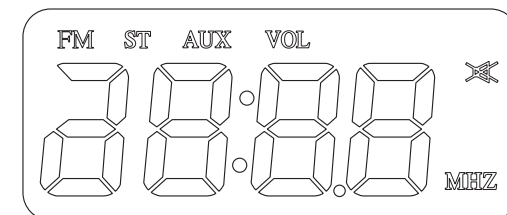

### FM Radio Operation

- 1) Press the button MODE on the front panel to select FM Radio Mode.
  - 2) Press button  to locate a radio station. The system will keep auto-scan tuning till catching one station.
- Note:* The ST worlds will be displayed on LCD screen when catching a stereo station.

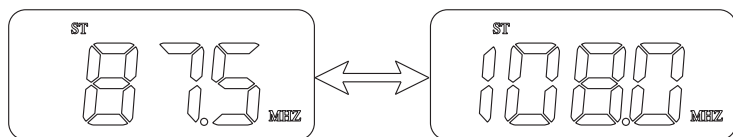

### AUX Mode Operation

- 1) Press the button MODE to select AUX mode operation.
  - 2) Adjust the volume control to a desired level.
- Note:* Words AUX will be displayed on LCD indicating the system works in AUX mode.

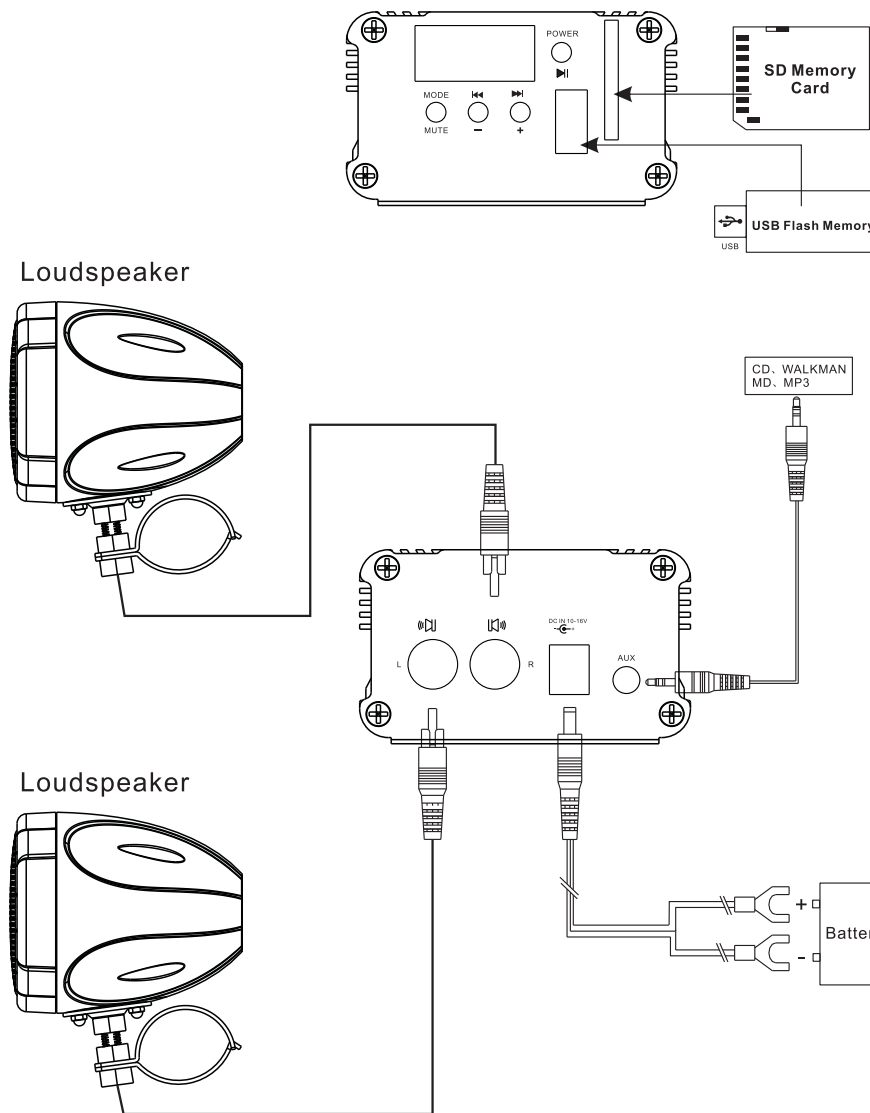
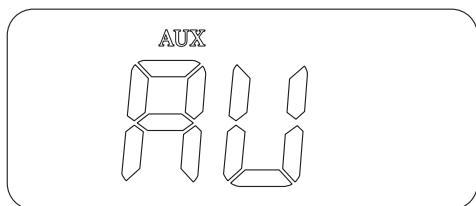

Connection diagram

## OPERATION INSTRUCTION

### First Time to Use the System

Connect the loudspeakers to the L-SP, R-SP RCA jacks on the rear panel.

Connect an external source to the AUX jack on the rear panel (if there is).

Connect the power cable to 12VDC power supply and plug the connector into the jack marked DC IN 9~16V

### Turn on/Turn off the system

Pressing the button POWER on the front panel for more than 2s, the system will be turned on and ready for operation\*.

Pressing the button POWER again for more than 2s will turn off the system.

\*Note: The system will memorize and recall the last state of operating mode (FM radio /AUX/USB /SD) .

### Select an Operation Mode

Pressing the button MODE on the front panel can change the mode from one to other(FM Radio—AUX—USB--SD mode) and select one of the mode you like.

Note: USB and SD modes are active only when a device is connected to the USB port/SD slot.

### Volume Control

Pressing the button + or – for more than 2s at any state, the system will be ready for the volume control with the range of 0~31 displayed on the screen. Adjust it to your desired setting without audio distortion.

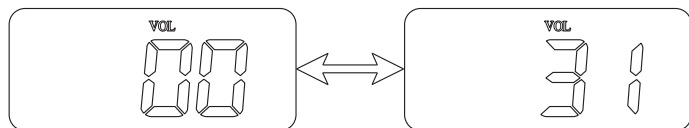

Note: The words VOL will be displayed on LCD screen during adjusting system volume.

### MUTE Function

Pressing the button MUTE for more than 2s will mute sounds from the outputs of the system at any state and disable it by pressing button MUTE again for more than 2s.

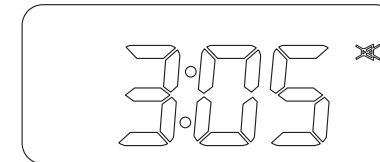

Note: will be blinking on the LCD when in MUTE state.

### USB/SD Mp3 Automatically Playing Function

The system will play Mp3 format songs automatically when an USB flash memory/SD card applied to the USD port/ SD slot on the front panel at any state.

1) Pressing the button to select last or next song.

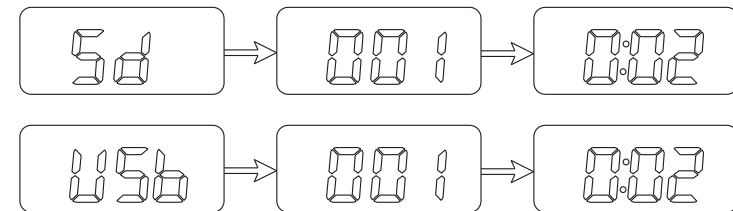

2) Pressing the button will pause the music playing and disable it by pressing it again.

