

PYLE

PyleUSA.com



PowerSports

PLMRBT20

Amplified Wireless BT Audio Controller

Waterproof-Rated Marine Receiver Remote Control

for Car, Truck, Boat, 4x4, PowerSport Vehicles

(300 Watt)

USER GUIDE

WIRE DIAGRAM

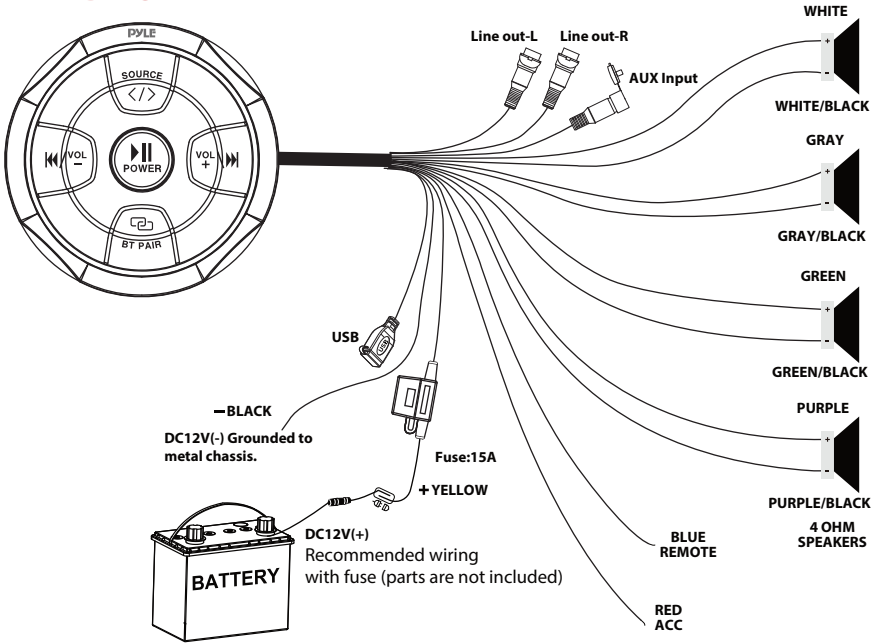

Wire Color	Description	Wire Color	Description
Yellow	Battery (+), 12dc	Gray	CH2 (+)
Black	Battery (-), Ground	Gray/Black	CH2 (-)
Red	ACC	Green	CH3 (+)
Blue	REMOTE	Green/Black	CH3 (-)
White	CH1 (+)	Purple	CH4 (+)
White/Black	CH1 (-)	Purple/Black	CH4 (-)

WIRELESS BT PAIRING AND CONNECTION

Power: Press and hold the power button to power **ON/OFF**.

Wireless BT Streaming Connection:

- Ensure BT ability is activated, then search for the **PLMRBT20** from your BT-enabled device. The light will turn blue and blinks while waiting for BT connection.
- The **PLMRBT20** BT Network Name will appear as "**PyleUSA**" (No password is required for connecting).
- When the BT is connected, the light will turn blue and stops blinking.
- Input mode indicator:** Blue light for BT, red light for AUX In, and purple light for USB.







AUX-IN

Short press ^{SOURCE} </> to switch BT mode/Aux-in /USB mode.

AUTO RECONNECTION

- a. When the device is out of the BT range, BT will be disconnected automatically, the light turns blue while blinking.
- b. BT will automatically reconnect when detected in range again in 10 minutes.
- c. Disconnected BT after 10 minutes, you need to process BT connection steps (above) to reconnect BT again.
- d. If the other device occupied the BT during this period (10mins), you need to process BT connection steps (above).
- e. If there is no connection during this period (10mins), it will turn to standby mode.

PLAYING MUSIC

1. Press and hold ^{POWER}  for 3 seconds to Power ON or OFF.
2. Short press ^{POWER}  to play music or pause.
3. Short press ^{SOURCE} </> to switch BT mode/Aux-in /USB mode.
4. Short press ^{VOL}  for next track, press and hold ^{VOL}  for volume up.
5. Short press /^{VOL} for previous track, press and hold /^{VOL} for volume down.
6. Press and hold ^{BT PAIR}  to disconnect BT.

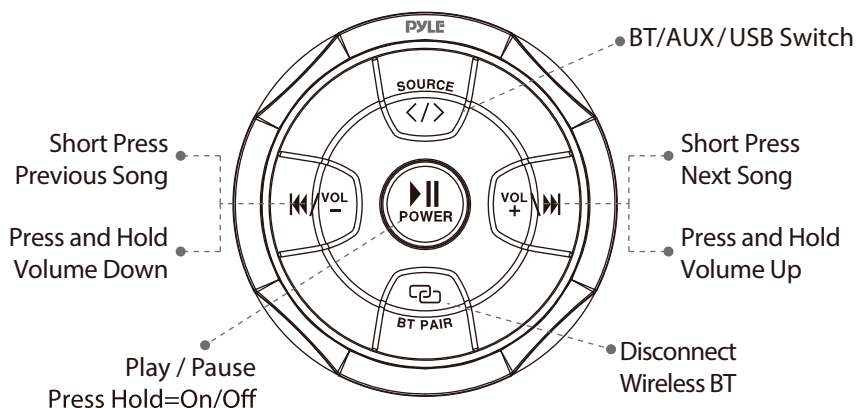

INSTALLATION (SEAMLESS FLUSH MOUNT)

Size:

96mm/3.8" (Out Diameter)

76mm/3.0" (Cutout Diameter)

93mm/3.7" (Depth)

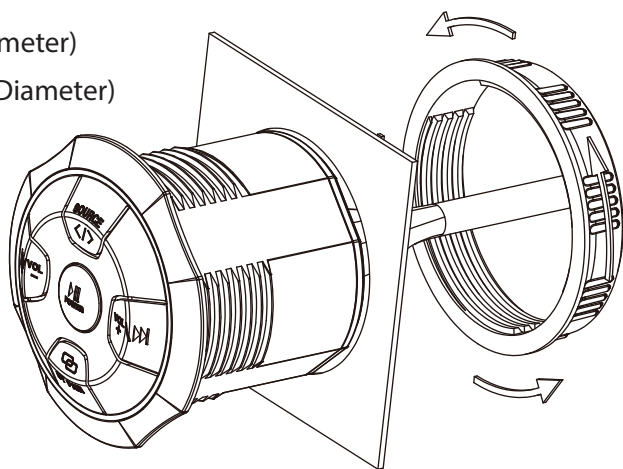

FEATURES:

- Universal Mount Wireless BT Streaming Control Unit
- Built-in Wireless BT Audio Receiver
- Waterproof-Rated Marine Grade Construction
- Water-Resistant & Weatherproof Design
- 4-Channel Amplifier Style
- Connect & Stream Audio from Additional External Devices
- Aux (3.5mm) Input connector Jack /USB Port
- Full Range Stereo Sound Reproduction
- Integrated Power Wiring Harness
- Pre-Amp RCA Out to Any OEM/Factory-Made Mono-Block/Full-Range Amplifier
- Flush Mount Mounting Kit Included
- Universal Vehicle Mounting
- Can be In-Console Flush Mount
- Anti-Thump Turn-On
- Soft Turn On / Off
- Overload & Power Protection Circuitry
- Used for Car, Truck, ATV, UTV, 4x4, Boat, Marine Watercraft, Power Sport Vehicles
- USB Charging (2A)

WIRELESS BT MUSIC STREAMING:

- Simple & Hassle-Free Pairing
- Instant Wireless Audio Streaming Receiver
- Works with All of Today's Latest Devices Smartphones, Tablets, Laptops, Computers, etc.
- Wireless BT Version: 5.0
- Wireless BT Network Name: 'PyleUSA'
- Wireless Range: 30'+ ft.

WHAT'S IN THE BOX:

- Wireless BT Control Unit
- Audio Connection Cable, 3.5mm

TECHNICAL SPECS:

- Power Output: 300 Watt MAX
- 4 x 35 Watts RMS @ 4 Ohm
- 4 x 75 Watts MAX @ 4 Ohm
- Marine Grade Waterproof Rating: IP-65
- Amplifier Type: Class-D
- T.H.D: 0.1%
- S/N Ratio: > 95 dB
- Channel Separation: > 65 dB
- Frequency Response: 10 - 40kHz
- Fuse: 15A
- Cut-Out Diameter: 3" –inches
- Mounting Depth: 3.7" –inches
- Power: DC 12V
- Total Unit Dimensions (L x W x H):
3.8" x 3.8" x 4.17" –inches (Flush Mount)

PYLE

PyleUSA.com



VISIT US ONLINE:
Have a question?
Need service or repair?
Want to leave a comment?
[PyleUSA.com/ContactUs](https://www.pyleusa.com/ContactUs)

PYLE

Questions? Issues?

We are here to help!

Phone: (1) 718-535-1800

Email: support@pyleusa.com



This product can expose you to a chemical or group of chemicals, which may include "Di (2-ethylhexyl) phthalate (DEHP)" which is known in the state of California to cause cancer, birth defects, or other reproductive harm.

WARNING: For more info, go to <https://www.p65warnings.ca.gov/>.