

PRJOS80 - PRJOS100 - PRJOS120

PORTABLE OUTDOOR PROJECTION SCREEN

PYLE
PyleUSA.com

USER GUIDE



This manual is used for outdoor screen operation.

For your better use of the product, please read and keep this manual carefully before installation and use. Due to the improvement of the product, the product you purchased may not be exactly the same as the description in the manual.

Product Features:

1. The screen is made of elastic polyester fabric, which can ensure the screen is flat after being tightened on the frame, which can perfectly present the projection picture.
2. The frame is made of stainless steel and is made up of multiple sections.
The elastic rope in the rod is connected in series for easy operation and use. After disassembly, the overall package is small, light in weight, and convenient to carry.
3. The structure is simple and easy to assemble.
4. The curtain is wrinkle-resistant, foldable and washable.
5. It can be used in outdoor environment with wind power below level 2.







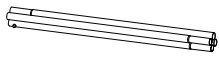

Questions? Issues?

We are here to help!

Phone: (1) 718-535-1800

Email: support@pyleusa.com

Parts:

	Vertical pole X 2 (Elastic buckle at one end)		Rope X 2
	Transverse pole X 2 (Elastic buckle at both ends)		Storage bag X 1
	Feet base X 2		Stake X (4~9)
	Corner connector X 2		Screen X 1
	Water bag X 2		

Parts Assembly Analysis Drawing

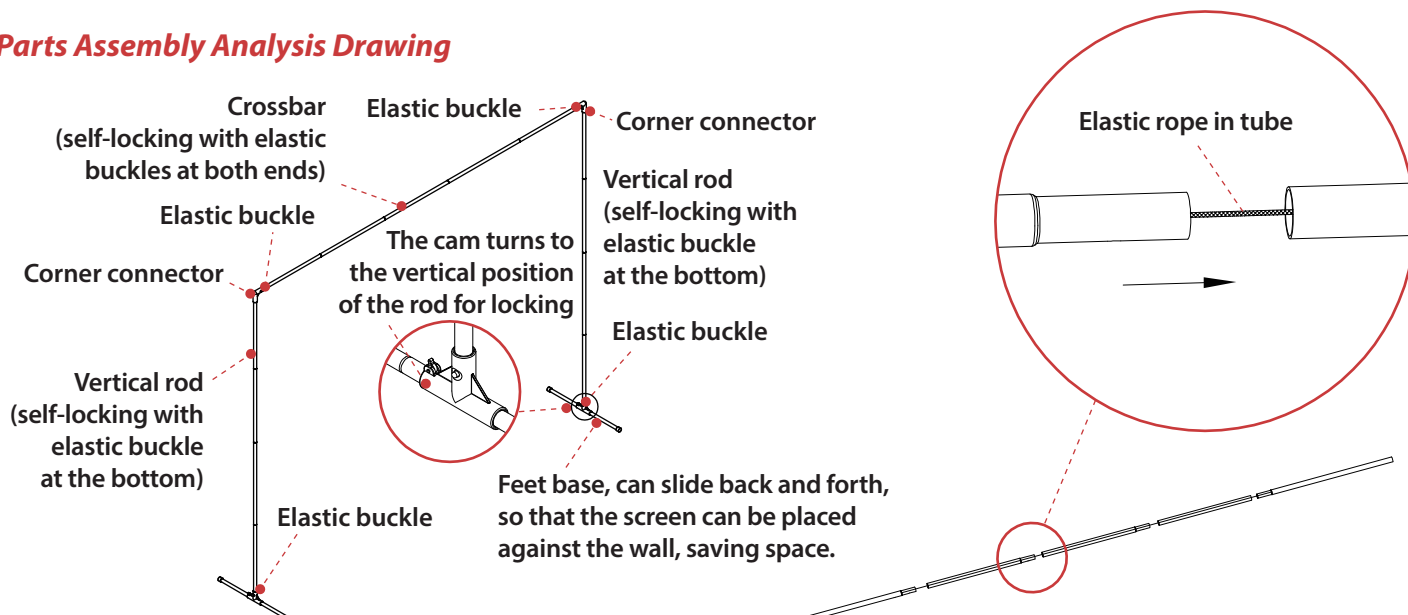

Installation Steps (Reverse operation when disassembling)

1. Install the vertical rod and feet base.

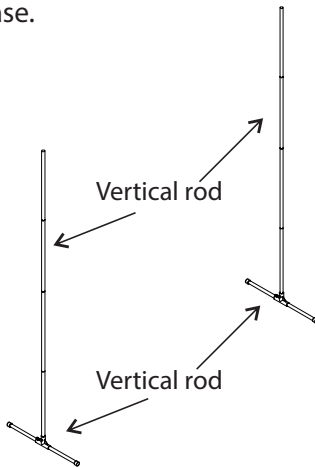

2. Put screen sides of the screen into the vertical pole.

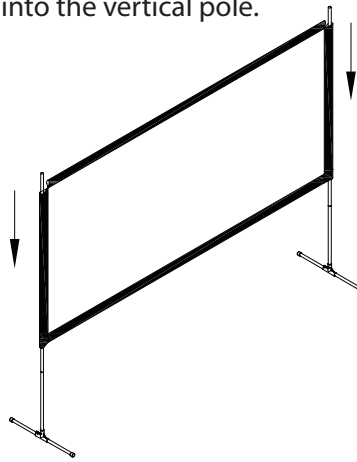

3. Insert the upper transverse pole and corner connector.

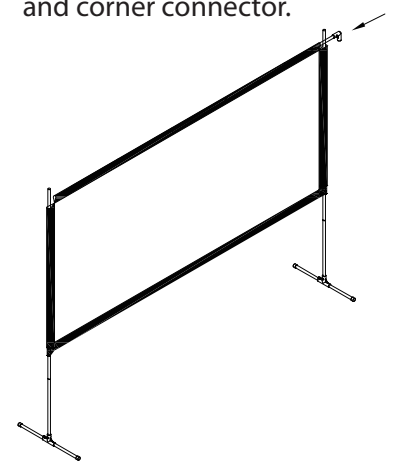

4. Insert the corner connector into the vertical poles on both sides

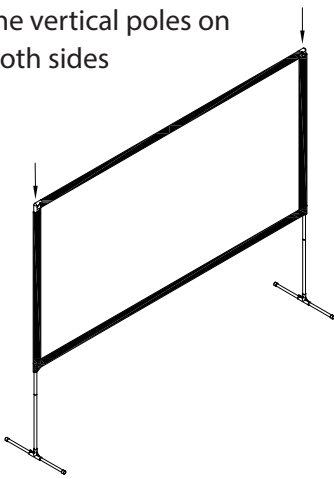

5. Push the vertical rod to both sides to make the screen equal width up and down.

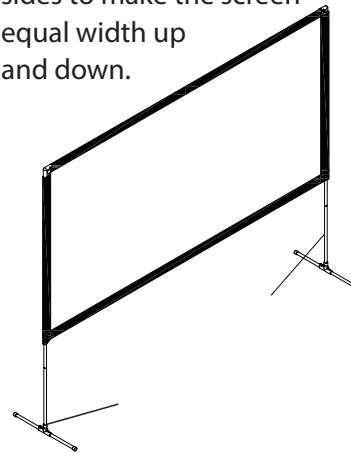

6. Fill the water bag with water and press it on both sides of the feet base.

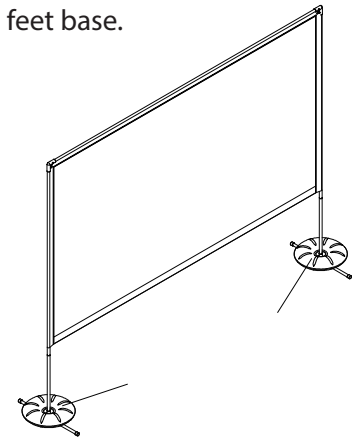

Outdoor Use

Note:

If the outdoor wind power exceeds level 2, this product cannot be used to avoid personal injury or product damage!

Use a water bag when there is no wind; when you use it outdoors, use a ropes to tie both sides of the screen to adjust the position of the bolt and the length of the ropes (as shown in the picture).

Note: Stake cannot be used on hard ground.

