



## ***PSBV600BT***

**Bluetooth Tabletop TV Soundbase Speaker System**

**USER MANUAL**



# Contents

---

---

<b>Important Safety Instructions .....</b>	<b>2</b>
Safety.....	2
Warning.....	3
<b>Identifying the Parts .....</b>	<b>4</b>
Main Unit .....	4
Remote Control .....	5
<b>Preparations.....</b>	<b>5</b>
Prepare the Remote Control.....	5
Replace the Remote Control Battery .....	6
Placing TV or Monitor.....	6
<b>Connections .....</b>	<b>7</b>
Use the OPTICAL Connection.....	7
Use the AUX Connection.....	7
Use the MP3 Link Connection.....	8
Connect Power .....	8
<b>General Operation.....</b>	<b>9</b>
Standby/ON .....	9
Select Modes .....	9
Adjust the Volume.....	9
Select the Equalizer.....	9
<b>AUX/OPTICAL/Mp3 Link Operation .....</b>	<b>9</b>
<b>BLUETOOTH Operation .....</b>	<b>10</b>
Pair Bluetooth-enabled Devices.....	10
Listen to Music from Bluetooth Device.....	11
<b>Troubleshooting .....</b>	<b>11</b>
<b>Specifications.....</b>	<b>12</b>
<b>Standard Accessories .....</b>	<b>12</b>

## Important Safety Instructions

	<b>CAUTION</b> RISK OF ELECTRIC SHOCK DO NOT OPEN	
CAUTION: TO REDUCE THE RISK OF ELECTRIC SHOCK, DO NOT REMOVE COVER (OR BACK). NO USER-SERVICEABLE PARTS INSIDE. REFER SERVICING TO QUALIFIED SERVICE PERSONNEL.		



The lightning flash with arrowhead symbol, within an equilateral triangle, is intended to alert the user to the presence of uninsulated "dangerous voltage" within the product's enclosure that may be of sufficient magnitude as to constitute a risk of electric shock to persons.



The exclamation point within an equilateral triangle is intended to alert the user to the presence of important operating and maintenance (servicing) instructions in the literature accompanying the appliance.

### Safety

- 1 Read these instructions** – All the safety and operating instructions should be read before this product is operated.
- 2 Keep these instructions** – The safety and operating instructions should be retained for future reference.
- 3 Heed all warnings** – All warnings on the appliance and in the operating instructions should be adhered to.
- 4 Follow all instructions** – All operating and use instructions should be followed.
- 5 Do not use this apparatus near water** – The appliance should not be used near water or moisture – for example, in a wet basement or near a swimming pool and the like.
- Clean only with a dry cloth.
- Do not block any ventilation openings. Install in accordance with the manufacturer's instructions.
- Do not install near any heat sources such as radiators, heaters, stoves, or other apparatus (including amplifiers) that produce heat.
- Do not defeat the safety purpose of the polarized or grounding plug. A polarized plug has two blades with one wider than the other. A grounding plug has two blades and a third grounding prong. The wide blade or the third prong is provided for your safety. If the provided plug does not fit into your outlet, consult an electrician for replacement of the obsolete outlet.
- Protect the power cord from being walked on or pinched, particularly at plugs, convenience receptacles and at the point where they exit from the apparatus.
- Only use attachments/accessories specified by the manufacturer.
-  Use only with the cart, stand, tripod, bracket, or table specified by the manufacturer, or sold with the apparatus. When a cart or rack is used, use caution when moving the cart/apparatus combination to avoid injury from tip-over.
- Unplug the apparatus during lightning storms or when unused for long periods of time.
- Refer all servicing to qualified personnel. Servicing is required when the apparatus has been damaged in any way, such as power supply cord or plug is damaged, liquid has been spilled or objects have fallen into the apparatus, the unit has been exposed to rain or moisture, does not operate normally, or has been dropped.
- This equipment is a Class II or double insulated electrical appliance. It has been designed in such a way that it does not require a safety connection to electrical earth.

**Caution:**

- Use of controls or adjustments or performance of procedures other than those described herein, may result in hazardous radiation exposure or other unsafe operation.
- To reduce the risk of fire or electric shock, do not expose this apparatus to rain or moisture. The apparatus must not be exposed to dripping or splashing and objects filled with liquids, such as vases, must not be placed on apparatus.
- The mains plug/appliance coupler is used as the disconnect device, the disconnect device must remain readily operable.

**Warning**

- The battery (battery or batteries or battery pack) must not be exposed to excessive heat such as sunshine, fire or the like.
- Before operating this system, check the voltage of this system to see if it is identical to the voltage of your local power supply.
- The ventilation should not be impeded by covering the ventilation openings with items such as newspaper, table-cloths, curtains etc. Make sure there is at least 20 cm of space above and at least 5cm of space on each side of the unit.
- Do not place this unit close to strong magnetic fields.
- Do not place the unit on the amplifier or receiver.
- Do not place this unit close to damp areas as the moisture will affect the life of the laser head.
- Should any solid object or liquid fall into the system, unplug the system and have it checked by qualified personnel before operating it any further.
- Do not attempt to clean the unit with chemical solvents as this might damage the finish. Use a clean, dry or slightly damp cloth.

- When removing the power plug from the wall outlet, always pull directly on the plug, never yank on the cord.
- No naked flame sources, such as lighted candles, should be placed on the apparatus.
- Changes or modifications to this unit not expressly approved by the party responsible for compliance will void the user's authority to operate the equipment.
- The marking label is pasted on the bottom of the equipment.

** DO NOT INGEST BATTERY, CHEMICAL BURN HAZARD**

The remote control supplied with this product contains a coin/button cell battery. If the coin/button cell battery is swallowed, it can cause severe internal burns in just 2 hours and lead to death. Keep new and used batteries away from children. If the battery compartment does not close securely, stop using the product and keep it away from children. If you think batteries might have been swallowed or placed inside any part of the body, seek immediate medical attention.

# Identifying the Parts

## Main Unit

Top view

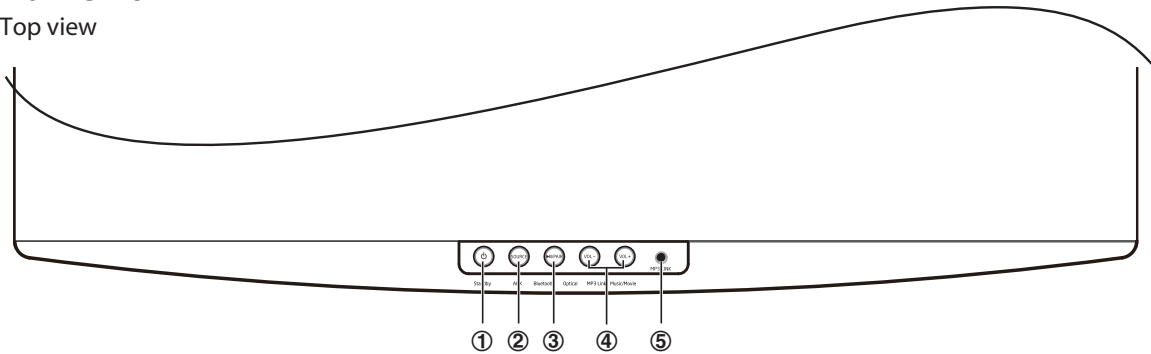

Front view

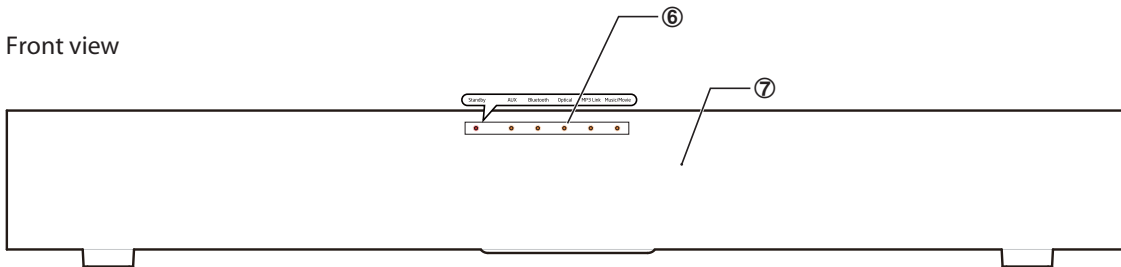

Back view

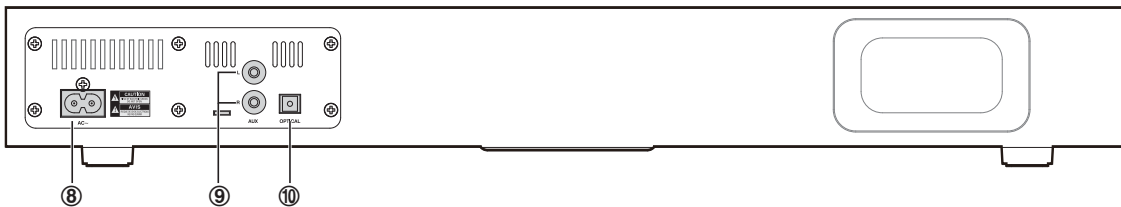

### 1

- Switch the unit between ON and STANDBY mode.

### 2 SOURCE

- Select the play function.

### 3 PAIR

- Play/pause/resume playback in Bluetooth mode.
- Press and hold this button to activate the pairing function in BLUETOOTH mode and disconnect the existing paired Bluetooth device.

### 4 VOL+/VOL-

- Increase/decrease the volume level.

### 5 MP3 LINK Socket

- Connect to an external audio device.

### 6 Status LED Indicators

- **Standby** indicator lights up **red** when the unit is in STANDBY mode.
- **Aux/Bluetooth/Optical/Mp3 Link** indicator lights up when which function is active.
- **Music/Movie**
  - In **MOVIE** EQ mode: light up steadily.
  - In **MUSIC** EQ mode: Light flash.

### 7 Remote Control Sensor

### 8 AC~ Socket

- Connect to power cord.

### 9 AUX (R/L) Socket

### 10 OPTICAL Socket

- Connect to a digital amplifier.

## Remote Control

### 1

- Switch the unit between ON and STANDBY mode.

### 2 SOURCE

- Select the play function.

### 3 VOL+/VOL-

- Increase/Decrease the volume level.

### 4

- Skip to previous track/skip to next track in Bluetooth mode.

### 5

- Play/pause/resume playback in Bluetooth mode.

### 6 PAIR

- Activate the pairing function in Bluetooth mode and disconnect the existing paired Bluetooth device.

### 7 MUTE

- Mute or resume the sound.

### 8 EQ

- Select a preset sound effect.

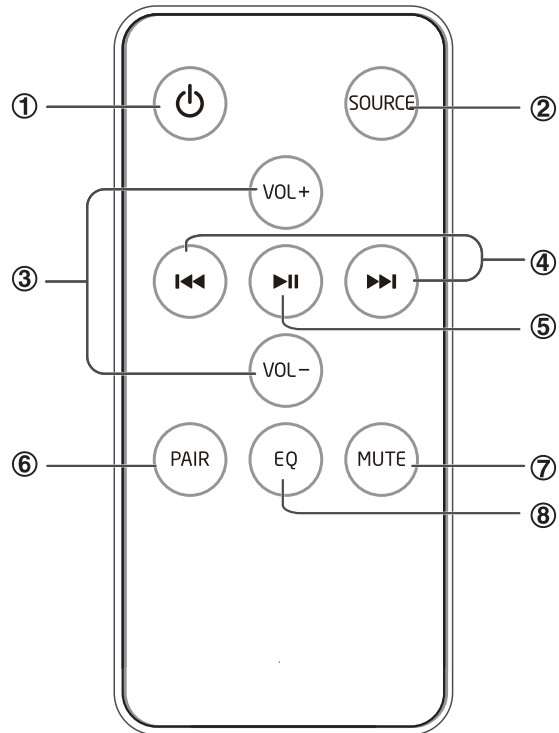

## Preparations

---

### Prepare the Remote Control

The provided Remote Control allows the unit to be operated from a distance.

- Even if the Remote Control is operated within the effective range (6m), remote control operation may be impossible if there are any obstacles between the unit and the remote control.
- If the Remote Control is operated near other products which generate infrared rays, or if other remote control devices using infra-red rays are used near the unit, it may operate incorrectly. Conversely, the other products may operate incorrectly.

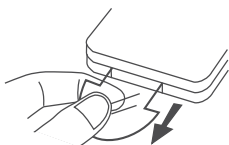

#### First-time use:

The unit has a pre-installed lithium CR2025 battery. Remove the protective tab to activate the remote control battery.

## Replace the Remote Control Battery

- 1 Pull out the battery tray and remove the old battery.
- 2 Place a new CR2025 battery into the battery tray with correct polarity (+/-) as indicated.
- 3 Insert the battery tray back into the slot.

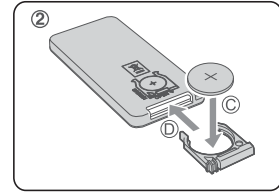
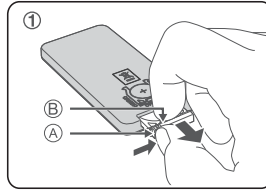

## Precautions Concerning Batteries

- When the Remote Control is not to be used for a long time (more than a month), remove the battery from the Remote Control to prevent it from leaking.
- If the batteries leak, wipe away the leakage inside the battery compartment and replace the batteries with new ones.
- Do not use any batteries other than those specified.
- Do not heat or disassemble batteries.
- Never throw them in fire or water.
- Do not carry or store batteries with other metallic objects. Doing so could cause batteries to short circuit, leak or explode.
- Never recharge a battery unless it is confirmed to be a rechargeable type.

## Placing TV or Monitor

The unit supports a TV up to a maximum dimension of 48 cm (W) x 22 cm (D) for its base and within a maximum load of 20 kg.

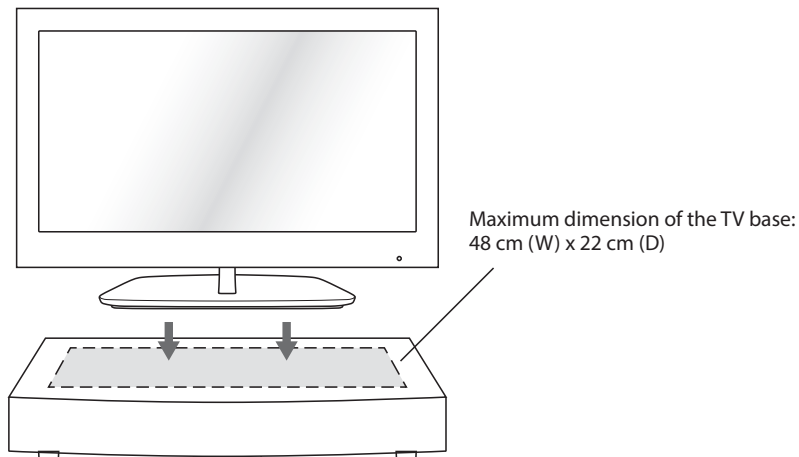

### Note:

Ensure the TV is placed properly. Turning the volume up too loud may cause the TV to vibrate and fall over.

# Connections

---

## Use the OPTICAL Connection

- Remove the protective cap of the **OPTICAL** socket, then connect an **OPTICAL** cable (not included) to the TV's OPTICAL OUT socket and the **OPTICAL** socket on the unit.

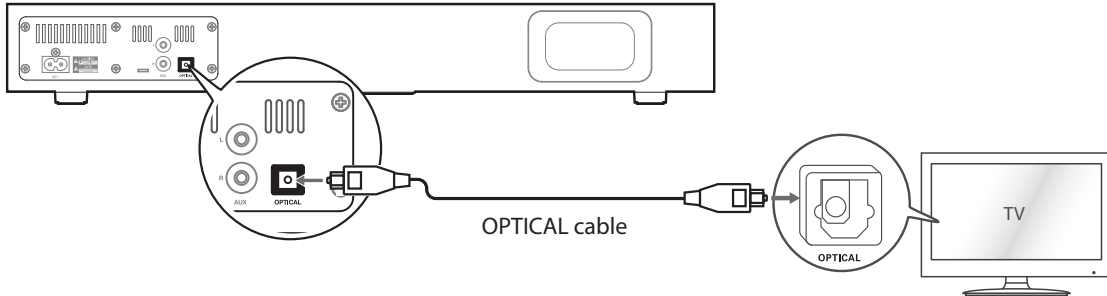

**Tip:** If there is no sound come out of the soundbar and the indicator flash quickly. Make sure the audio setting of your source player (e.g. DVD player, game player, TV) is setted to PCM with **OPTICAL** input.

## Use the AUX Connection

- Use a RCA stereo audio cable (not included) to connect the TV's audio output sockets to the **AUX (R/L)** socket on the unit.

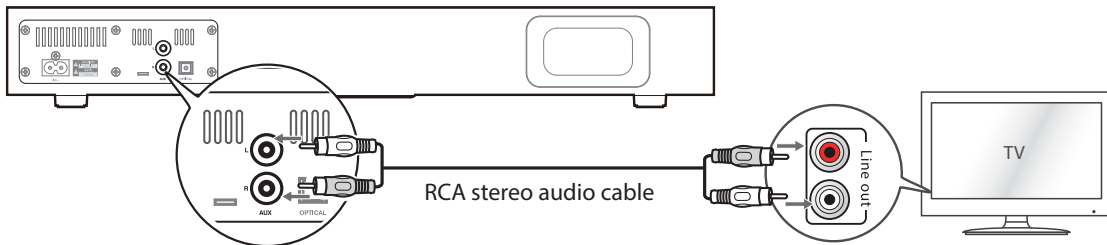

- Use a 3.5mm to RCA audio cable ( included) to connect the TV's headphone socket to the **AUX (R/L)** socket on the unit.

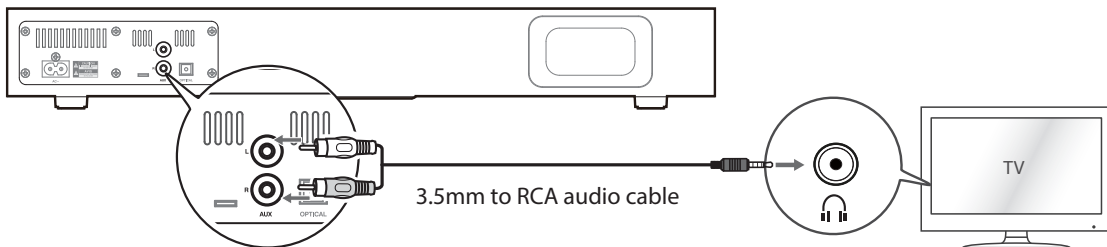



## Use the MP3 Link Connection

- Connect 3.5mm to 3.5mm audio cable (included) to the **MP3 LINK** socket on the unit and the audio output socket on external audio device (e.g.MP3 player, iPhone...).

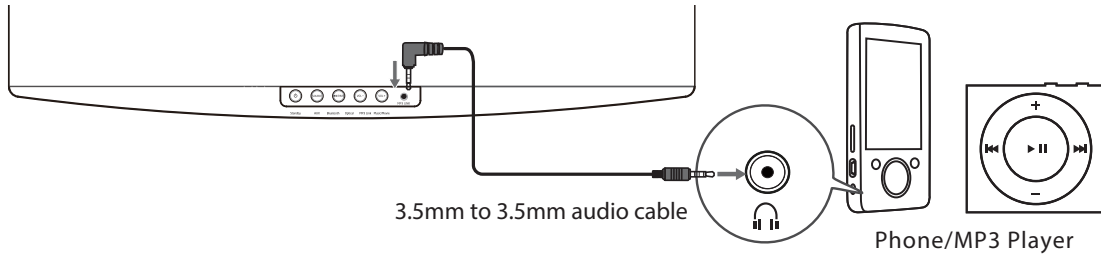

## Connect Power

- **Risk of product damage!** Ensure that the power supply voltage corresponds to the voltage printed on the back or the underside of the unit.
- This unit is designed to operate with the provided mains cable.
- Connecting the unit to any other power source may cause damage to the unit. Unwind the mains cable to its full length. Connect the mains plug to a mains socket. Make sure the mains plug is fully inserted into the mains socket.
- Connect the power to the **AC~** socket on the unit and a wall outlet.

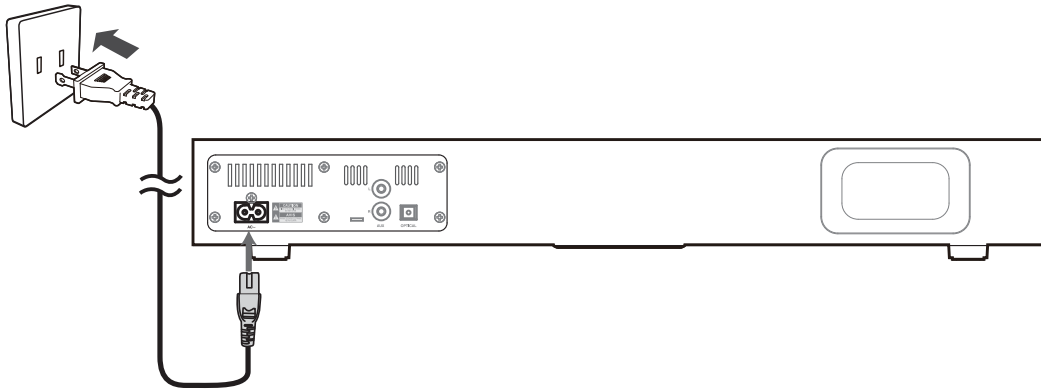

## Note:

- Ensure all connections are connected before connecting to the mains power socket.
- Be sure to unplug the power cord from the outlet when the system is not in use for an extended period of time.

## General Operation

---

### Standby/ON

When you first connect the unit to the mains socket, the unit will be in standby mode and the Standby Indicator will be red.

- Press the **⏻** button to switch the main unit ON.
- Press the **⏻** button again to switch the unit back to STANDBY mode. The POWER indicator will light up red.
- Disconnect the mains plug from the mains socket if you want to switch the unit OFF completely.
- If the unit is idle for over 15 minutes, the unit will automatically switch to Standby mode.

### Select Modes

Press the **SOURCE** button repeatedly on the unit or on the remote control to switch between **AUX**, **OPTICAL**, **MP3 Link** and **BLUETOOTH** modes.

### Adjust the Volume

- Press the **VOL +/-** button to adjust the volume.
- If you wish to turn the sound off, press the **MUTE** button on the remote control. Press the **MUTE** button again or press the **VOL +/-** button to resume normal listening.
- While adjusting the volume, the status indicator flashes quickly.
- While the volume level reaches its maximum level, if you press the **VOL +** button again, the status indicator flashes once. While the volume level reaches its minimum level, if you press the **VOL -** button again, the status indicator flashes once.

### Select the Equalizer

While playing, press the **EQ** button on the remote control to select between preset equalizers: **Movie** (recommended for viewing movies), **Music** (recommended for listening to music).

- When **AUX** or **OPTICAL** mode is selected, the equaliser will be set to **MOVIE**. The **Music/Movie** Indicator will light up steadily.
- When **BLUETOOTH** or **MP3 LINK** mode is selected, the equaliser will be set to **MUSIC**. The **Music/Movie** Indicator will flash

## AUX/OPTICAL/Mp3 Link Operation

---

- 1 Ensure that the Sound Stand is connected to the TV or audio device.
- 2 Press the **SOURCE** button repeatedly on the unit or on the remote control to switch between **AUX** or **OPTICAL** or **Mp3 Link** mode.
- 3 Operate your audio device directly for playback features.
- 4 Press the **VOL +/-** button to adjust the volume to your desired level.

## **BLUETOOTH Operation**

---

You can listen to tracks from a media device if it is connected to the unit via Bluetooth.

### **Pair Bluetooth-enabled Devices**

#### **Note:**

- The operational range between the main unit and a Bluetooth device is approximately 8 meters.
- Before you connect a Bluetooth device to this unit, familiarize yourself with the Bluetooth capabilities of the device.
- Compatibility with all Bluetooth devices is not guaranteed.
- Any obstacle between this unit and a Bluetooth device can reduce the operational range.
- Keep this unit away from other electronic devices that may cause interference.

#### **To connect your device to the unit via Bluetooth, follow the steps below:**

- 1 During ON mode, press the **SOURCE** button repeatedly on the unit or on the remote control to select **Bluetooth** mode. The Bluetooth indicator will flash slowly.
- 2 The system has entered pairing mode.
  - Or press the **PAIR** button on the remote control or press and hold the **▶ II/PAIR** button on the main unit to be searchable. The Bluetooth indicator will flash rapidly.
- 3 Activate your Bluetooth device and select the search mode. "**PSBV600BT**" will appear on your Bluetooth device list.
- 4 Select "**PSBV600BT**" in the pairing list. The Bluetooth indicator will light up solidly while the pairing succeeds.
- 5 To disconnect the Bluetooth function, switch to another function on the unit or disable the function from your Bluetooth device.

#### **Tips:**

- Enter "0000" for the password if necessary.
- If there is an existing connection, press the **PAIR** button on the remote control or press and hold the **▶ II/PAIR** button on the main unit to re-activate the pairing mode, the existing connection will be interrupted, the BLUETOOTH indicator will flash.
- If no other Bluetooth device pairs with this player within two minutes, the player will recover its previous connection.
- The player will also be disconnected when your device is moved beyond the operational range.
- If you want to reconnect your device to this player, place it within the operational range.
- If the device is moved beyond the operational range, when it is brought back, please check if the device is still connected to the player.
- If the connection is lost, follow the instructions above to pair your device to the player

again.

### **Listen to Music from Bluetooth Device**

- If the connected Bluetooth device supports Advanced Audio Distribution Profile (A2DP), you can listen to the music stored on the device through the player.
- If the device also supports Audio Video Remote Control Profile (AVRCP), you can use the player's remote control to play music stored on the device.
  1. Pair your device with the player.
  2. Play music via your device (if it supports A2DP).
  3. Use supplied remote control to control play (if it supports AVRCP).
    - To pause/resume play, press the ►|| button.
    - To skip to a track, press the ◀◀, ▶▶ buttons.

## **Troubleshooting**

---

To keep the warranty valid, never try to repair the system yourself. If you encounter problems when using this unit, check the following points before requesting service.

### **No power**

- Ensure the mains cable is connected securely.
- Make sure that the unit is switched on.

### **The remote control does not function**

- Use the remote control near the unit.
- Point the remote control at the remote control sensor on the unit.
- Replace the battery in the remote control with a new one.
- Remove any obstacles between the remote control and the unit.

### **Loud hum or noise is heard**

- The plugs and sockets are dirty. Wipe them with a cloth slightly moistened with an appropriate non-abrasive cleaning solution.

### **The unit does not respond when pressing any buttons**

- The unit may freeze up during use. Switch the unit off and then on again at the mains socket to reset the unit.

### **No sound output**

- Make sure that the unit is not muted. Press MUTE or VOL + to resume normal listening.
- Ensure the audio setting of the input source (e.g. TV, game console, DVD player, etc.) is set to PCM mode while using optical connection.

### **The sound output effect sounds unfamiliar**

- Press EQ on the remote control to select preset EQ mode for the optimal sound output

effect.

### **I can't find the Bluetooth name of this unit on my Bluetooth device for Bluetooth pairing**

- Ensure that the unit is switch on.
- Ensure that the Bluetooth function is activated on your Bluetooth device.
- The unit has a Bluetooth function that can receive a signal within 8 metres. Keep a distance within 8 metres between.

## **Specifications**

---

---

### **General**

Power requirements .....	AC120V~ 60Hz
Power consumption.....	18 W
Output power RMS.....	15W x 2 + 30W
Total harmonic distortion .....	1%(1kHz, 1W)
Audio input sensitivity .....	700mV
Frequency response.....	40Hz - 20KHz
Dimension (W x H x D) .....	525 x 75 x 305 mm

### **Speakers**

Front Impedance .....	3Ω X 2
Woofer Impedance .....	6Ω

### **Remote**

Distance.....	6m
Angle.....	30°

## **Standard Accessories**

---

---

Remote Control .....	x 1
Instruction Manual .....	x 1
AC Power Cord .....	x 1
RCA - 3.5mm audio Cable .....	x 1

- Design and specifications are subject to change without notice.