

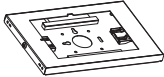

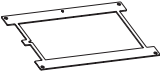

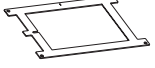

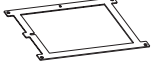

PSPADLKW08W

Security Anti-Theft iPad Wall Mount

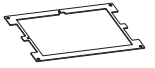
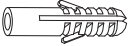
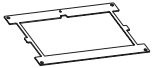
USER GUIDE

ITEM	DESCRIPTION	QUANTITY	ITEM	DESCRIPTION	QUANTITY
A	 Enclosure	1	G	 Panel 6	1
B	 Panel 1	1	H	 M4 x12	4
C	 Panel 2	1	I	 ST4.8 x30	4
D	 Panel 3	1	J	 Ø6 x30	4
E	 Panel 4	1	K	 key	1
F	 Panel 5	1			

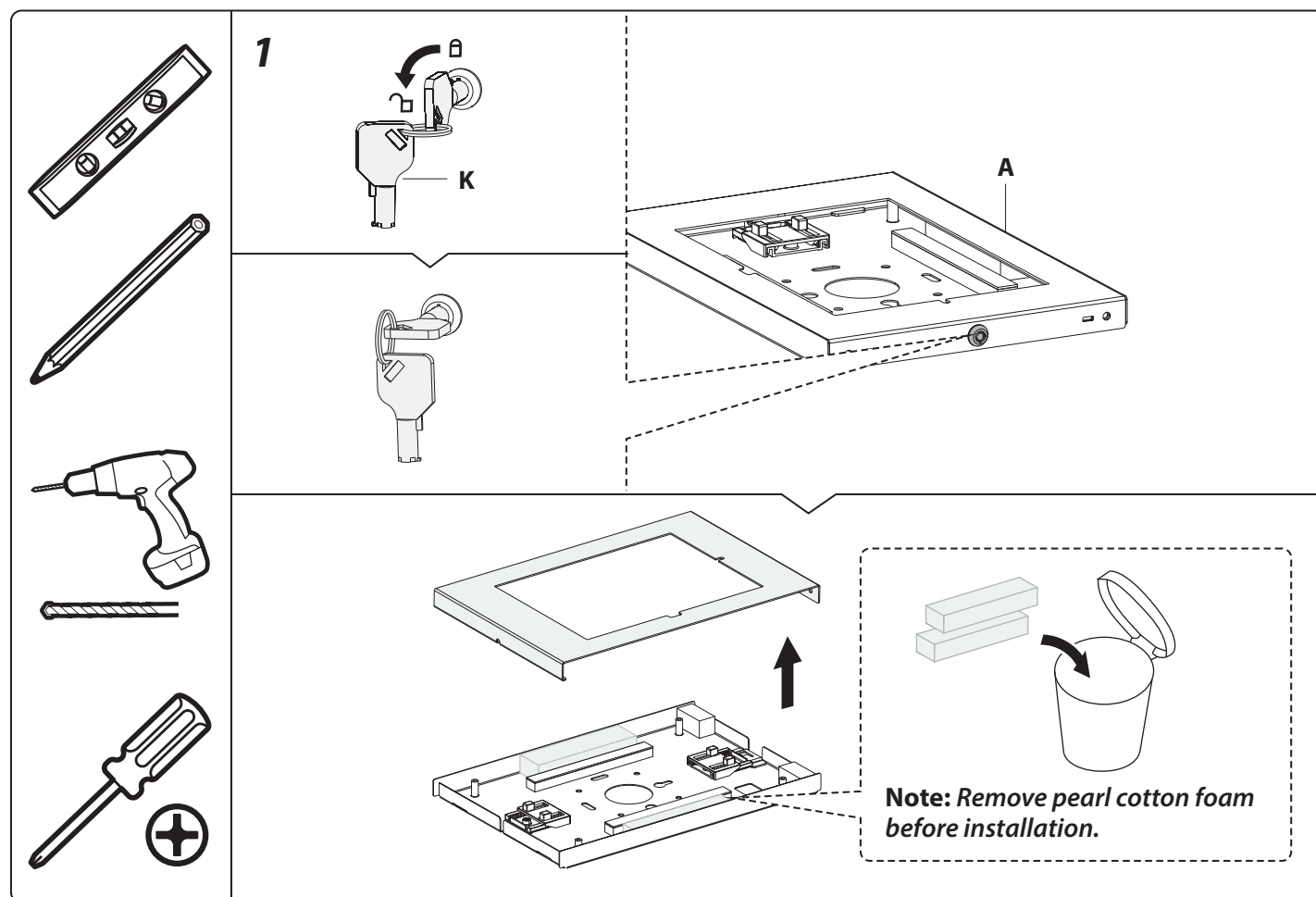

California Prop 65 Warning

WARNING:

This product may expose you to chemicals, which is known to the state of California to cause cancer, birth defects and other reproductive harm. Do not ingest.

For more info go to: www.P65warnings.ca.gov



Questions or Comments?

We are here to help!

Phone: 1.718.535.1800

PyleUSA.com/ContactUs

2

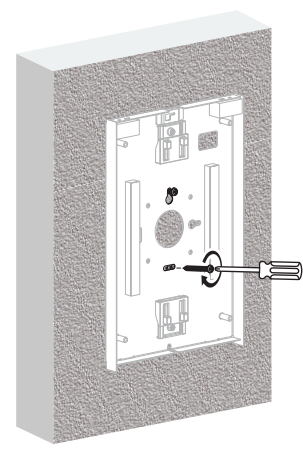
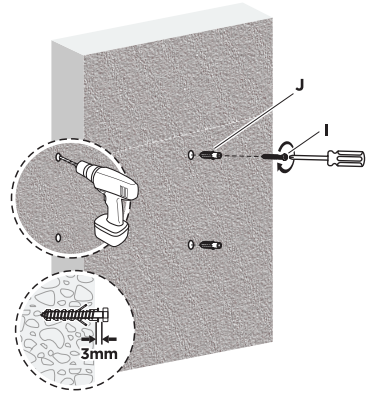
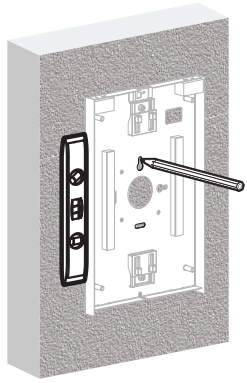
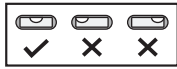
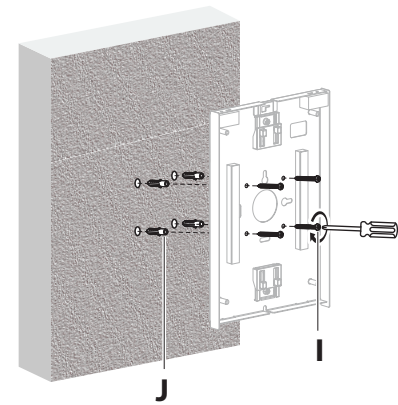
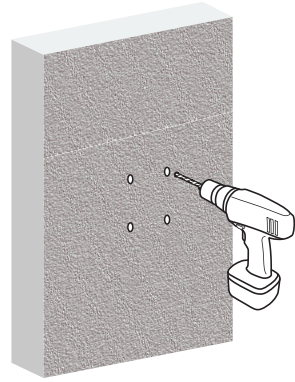
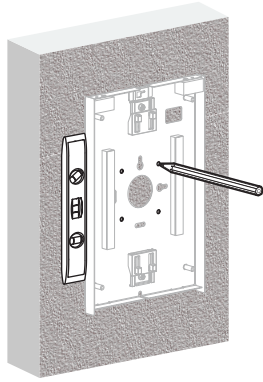
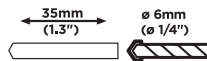

3 B/C/D/E/F/G

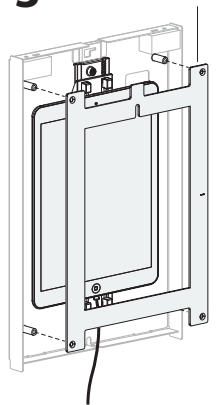

Attach the panel to the enclosure using 4 screws (H). Before completely tightening the screws, adjust the 2 claws to hold the tablet and to ensure the screen is aligned and visible through the front panel.

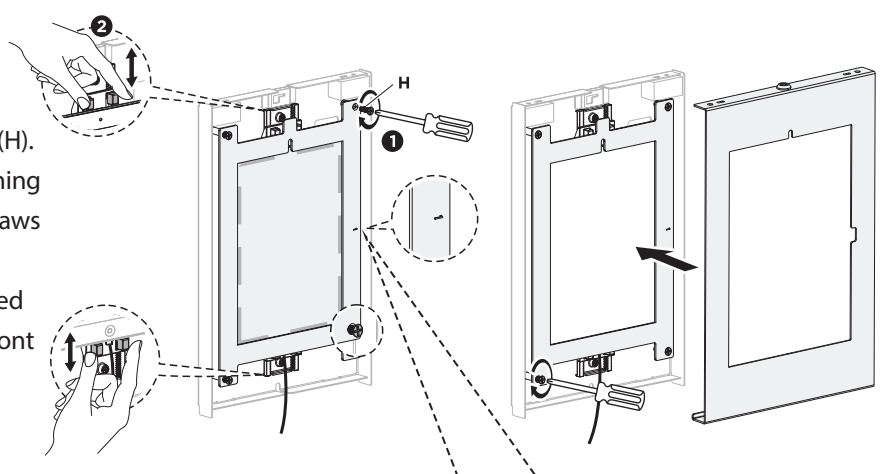

4

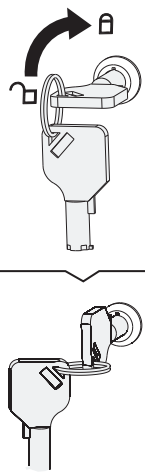
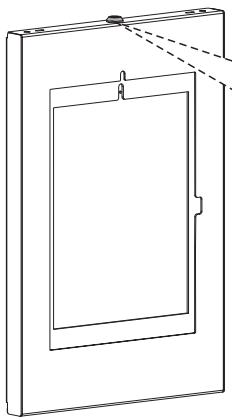

- Panel 1:** For 9.7" iPad 5/6, iPad Air 1/2 and iPad Pro (Gen 1)
- Panel 2:** For 10.2" iPad 7/8/9 & 10.5", iPad Air 3 and iPad Pro (Gen 2)
- Panel 3:** For 11" iPad Pro (Gen 3/4/5) & 10.9" iPad 10, iPad Air 4
- Panel 4:** For 10.4" Samsung Galaxy Tab A7
- Panel 5:** For 10.1" Samsung Galaxy Tab A
- Panel 4:** For 10.4" Samsung Galaxy Tab S6 Lite

Choose the corresponding panel according to the tablet.
Register Product

Thank you for choosing PyleUSA. By registering your product, you ensure that you receive the full benefits of our exclusive warranty and personalized customer support. Complete the form to access expert support and to keep your PyleUSA purchase in perfect condition.

Start Here



Model Number:
PSPADLKW08W
PyleUSA.com/pages/register