

**PYLE**<sup>®</sup>  
PyleUSA.com

Bluetooth 5.1 Channel Home Theater System  
Surround Sound Speakers & A/V Amplifier Receiver, FM Radio



**PT589BT**

**HDMI**

**O w n e r ' s M a n u a l**

---

---

# TABLE OF CONTENTS

## Important Safety Information

Owner's Record .....	1
For Customers in the United States .....	1
Caution.....	1
Note to Home Theater System Installer.....	1

## Installation

Front Panel Display Window.....	2
Rear Panel Connectors.....	3
Battery Installation.....	4
Using the Remote Control.....	5

## Basic Operations

Turn On/Off the Power.....	6
Master Volume Control.....	6
Side Left Channel Volume Control.....	6
Side Right Channel Volume Control.....	6
Center Channel Volume Control.....	6
Subwoofer Volume Control.....	6
How to Adjust Treble.....	6
How to Adjust Bass.....	6
How to Play HDMI.....	6
How to Play AUX.....	6
How to Play Tuner.....	6
Select Program	
Listen to the Preset Program	
Memory Program	
How to Mute.....	7
Introduction of DSP Control Key .....	7
Introduction of Source Output Selector Area.....	7
How to Play Bluetooth.....	7

## Additional Information

Precautions.....	8
Troubleshooting.....	10
Specifications .....	12

# Important Safety Information

## OWNER'S RECORD

The model and serial number are located on the rear of the unit. Record the serial number in the space provided below. Refer to them whenever you call upon your PyleUSA regarding this product.

Model No. \_\_\_\_\_

Serial No. \_\_\_\_\_

## FOR CUSTOMERS IN THE UNITED STATES

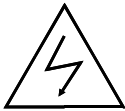

This symbol is intended to alert the user to the presence of un-insulated “dangerous voltage” within the product’s enclosure, it may be of sufficient magnitude to constitute a risk of electric shock to persons.



**CAUTION: TO REDUCE THE RISK OF ELECTRIC SHOCK. DO NOT REMOVE COVER (OR BACK). REFER SERVICING TO QUALIFIED SERVICE PERSONNEL.**



This symbol is intended to alert the user to the presence of important operating and maintenance (servicing) instructions in the literature accompanying the appliance.

## CAUTION

You are cautioned that changes or modifications not expressly approved in this manual could void your authority to operate this equipment.

- To reduce the risk of fire or electric shock, do not expose this apparatus to rain or moisture.
- To prevent fire, do not cover the ventilation of the apparatus with newspapers, table-cloths, curtains and etc. Do not place lighted candles on the apparatus.
- To prevent fire or shock hazard, do not place objects filled with liquid, such as vases, on the apparatus.
- Do not install the appliance in a confined space, such as a bookcase or built-in cabinet.
- Install this system so that the power cord can be unplugged from the wall socket immediately in the event of trouble.
- Batteries or batteries installed apparatus shall not be exposed to excessive heat such as sunlight or fire.

### Note to Home Theater System Installer:

This reminder is provided to call Home Theater System installers’ attention to Article 820-40 of the NEC that provides guidelines for proper grounding, in particular, specifies that the cable ground shall be connected to the grounding system of the building as close to the point of cable entry as possible.

# Installation

## INDICATORS ON FRONT PANEL DISPLAY WINDOW

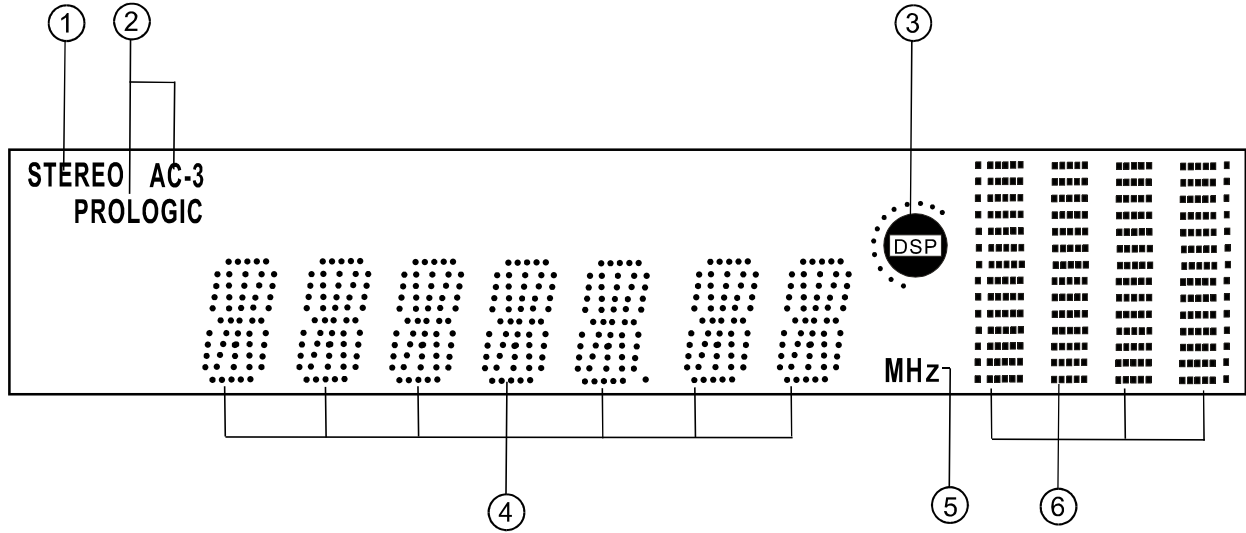

Name	Function
① STEREO                      AUX/TUNER INPUT	Lights up when input mode is set to AUX1, AUX2.
② AC-3 PROLOGIC              HDMI INPUT	Lights up when input mode is set to 5.1 channel or HDMI1, HDMI2.
③ DSP                              DSP STATE ICON	Lights up when play DSP effect.
④ DIGITAL DISPLAY	Lights up to display value of current input mode.
⑤ MHz                              MHZ ICON	Lights up when Tuner input is selected and indicates the value on the display for MHz.
⑥ SPECTRUM DISPLAY	Lights up to display the spectrum of different sound channels.

## REAR PANEL CONNECTORS

Please install this system according to the following schematic diagram.

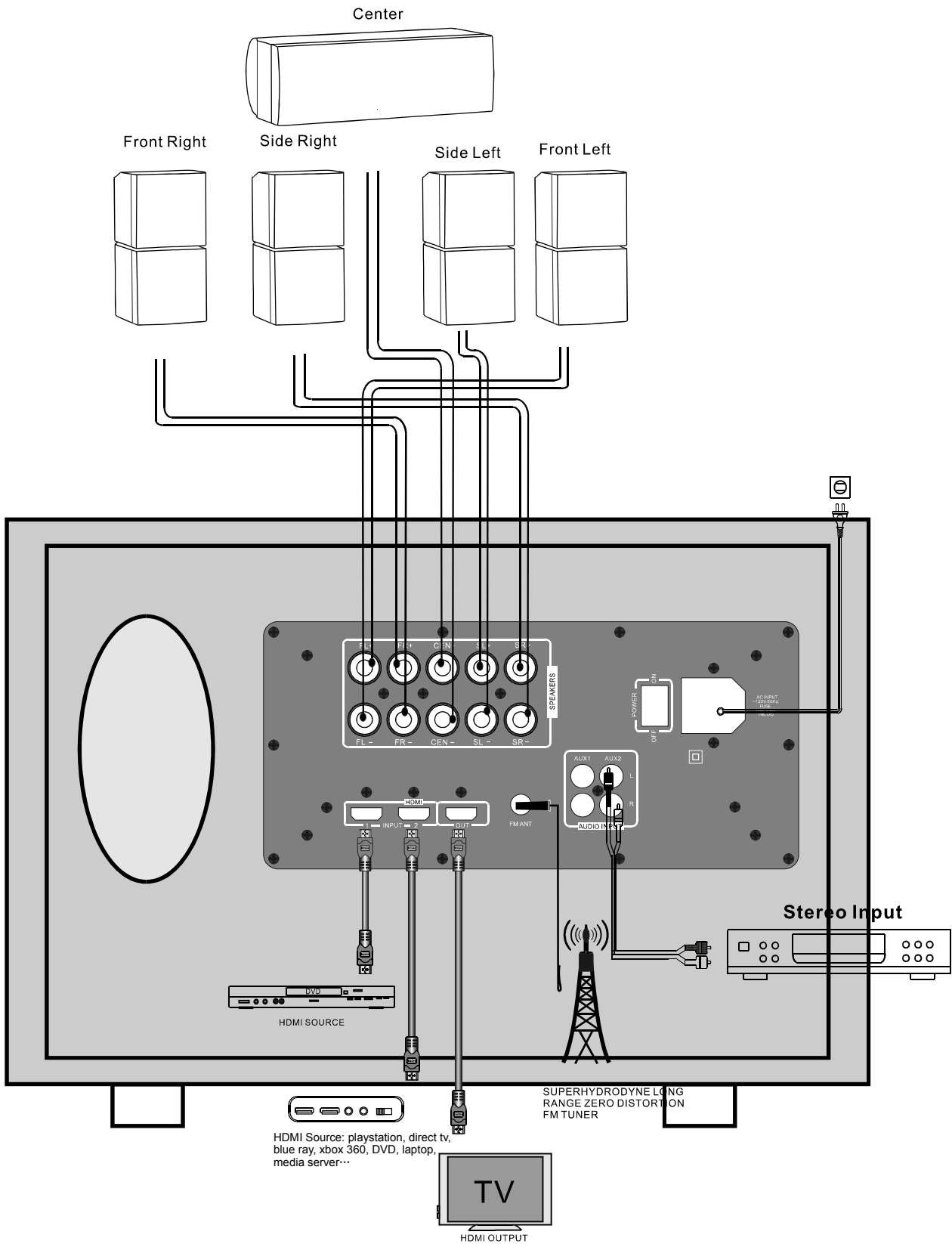

## BATTERY INSTALLATION

1. On the back of the remote control, push the tab and lift off the battery cover.
2. Obtain two (2) fully-charged AAA batteries. Match the “+” and “-” marks on the batteries to the “+” and “-” marks in the battery case, then insert the new batteries.
3. Align the cover keys with the case holes and press the cover back into place. The tab should click when the cover is locked.
4. Test the unit by pressing POWER or any mode key. If the batteries are inserted correctly, the selected mode key will blink once.

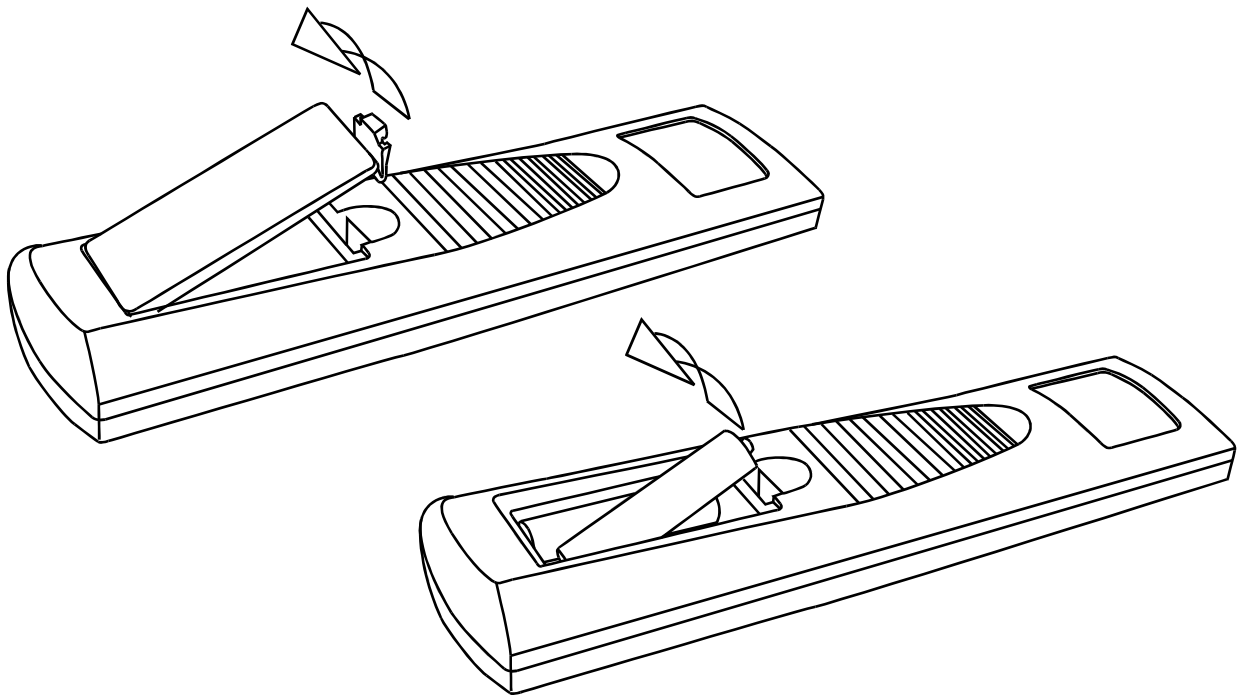

### Notes

- Do not leave the remote control in an extremely hot or humid place.
- Do not use a new battery with old ones.
- Do not mix manganese batteries with other kinds of batteries.
- Do not expose the remote sensor to direct sunlight or lighting apparatuses. Doing so may cause a malfunction.
- If you do not intend to use the remote control for an extended period of time, remove the batteries to avoid possible damage from battery leakage and corrosion.
- When you replace the batteries, the remote buttons may be reset to their factory settings. If this happens, reset the buttons again.

### Tips

Under normal conditions, the batteries should last for about 3 months. When the remote no longer operates the receiver, replace all the batteries with new ones.

## USING THE REMOTE CONTROL

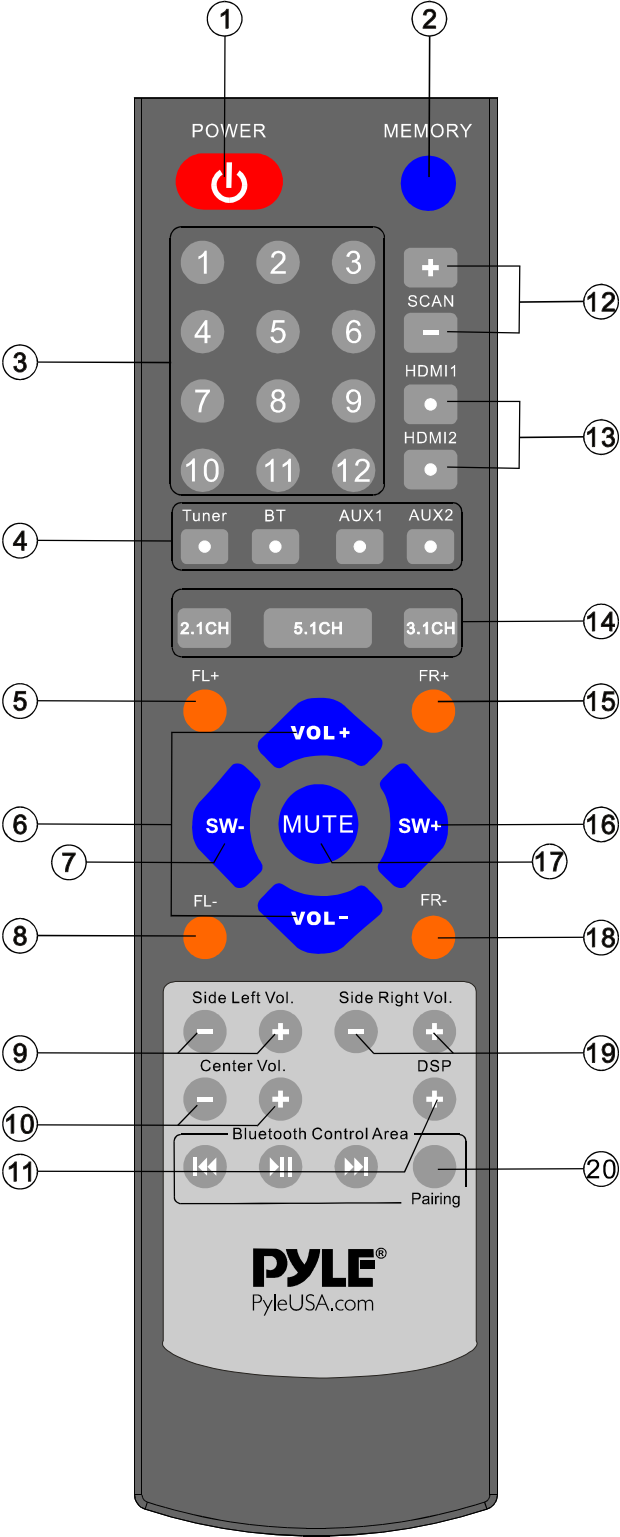
<p><b>1. POWER</b> Button-Toggle Power OFF and ON</p>		<p><b>2. MEMORY</b> Button</p>
<p><b>3. TUNER</b> Number Button</p>		<p><b>12. TUNER</b> Band Adjustment Button</p>
<p><b>4. INPUT MODE</b> Selector Area</p>		<p><b>13. HDMI</b> Control Selector Button</p>
<p><b>5. LEFT</b> Balance Volume Increase Button</p>		<p><b>14. CHANNEL SOURCE OUTPUT</b> Selector Area</p>
<p><b>6. MASTER</b> Volume Control Button</p>		<p><b>15. RIGHT</b> Balance Volume Increase Button</p>
<p><b>7. SUBWOOFER</b> Volume Decrease Button</p>		<p><b>16. SUBWOOFER</b> Volume Increase Button</p>
<p><b>8. LEFT</b> Balance Volume Decrease Button</p>		<p><b>17. MUTE</b> Control Button</p>
<p><b>9. SIDE LEFT</b> Volume Adjustment Button</p>		<p><b>18. RIGHT</b> Balance Volume Decrease Button</p>
<p><b>10. CENTER</b> Volume Adjustment Button</p>		<p><b>19. SIDE RIGHT</b> Volume Adjustment Button</p>
<p><b>11. DSP</b> Control Selector Button</p>		<p><b>20. Bluetooth Control Area</b></p>

# Basic Operation



## Turn On/Off the Power

Press “” key to control the power on and off.



## Master Volume Control

Press the “” or “” Key to adjust the main channel volume.



## Side Left Channel Volume Control

Press “ ” key on the remote control, screen display the SL volume, press “-ADJUST+” key to adjust side left channel volume.



## Side Right Channel Volume Control

Press “ ”Key on the remote control, screen display the SR volume, press “-ADJUST+” key to adjust side right channel volume.



## Center Channel Volume Control

Press “ ”key on the remote control, screen display the CEN volume, press “-ADJUST+” key to adjust center channel volume.



## Subwoofer Volume Control

Press “ ” key on the remote control, screen display the SW volume, press “-ADJUST+” key to adjust subwoofer channel volume.

## How to Play HDMI



Make sure HDMI1/HDMI2 connection lines are correct, Press the “ / ” key to play HDMI.

## How to Play AUX



Make sure AUX1/AUX2 connection lines are correct, Press the “ / ” key to play AUX.

## How to Play Tuner

### 1. Select Program

Use “” key to select FM band. Press the “ ” key to adjust the band of tuner.

Press the “ ” key for 2 seconds, the FM will search automatically. You can press

the “ ”key once or the input mode selector to stop the function.



## 2. Listen to the Preset Program



Press the number keys “10 11 12” to select the radio program that you already saved.

Once selected, screen will display the radio program’s frequency in the memory area.

## 3. Memory Program

When you receive a clear radio program, press the “” key first, and then the



screen displays the “Memory” icon. Press one of the 12 “10 11 12” number key on the remote control to select the memory station. If you want to extract the channel you saved, just press the number key you selected.

### How to Mute



Press “” key to turn sound off/on.

Press again to restore the audio to the original level.

### Introduction of DSP Control Key





Press the key “” repeatedly to switch to different operations: Live, Hall or Church. All the above functions can give different sound effects.

### Introduction of Source Output Selector Area

- Press “” to receive 5.1 channel. (5.1 channel output is the default mode)
- Press “” to receive 3.1 channel. (Side left speaker and Side right speaker mute)
- Press “” to receive 2.1 channel. (Side left speaker, Side right speaker and Center speaker mute)

### How to Play Bluetooth

Pairing with a bluetooth sender as the following manual.

1. “” play the previous song.
2. “” play the next song.
3. “” play/pause the song.
4. “” pairing the bluetooth sender.

### How to Pair the bluetooth receiver

The system have built in a bluetooth receiver. If you need to pair with a bluetooth sender(mobile phone), first open the system, and press the “” key on the remote control, the VFD will show “pairing” and flicker. Then search the bluetooth receiver(**Device ID: PyleUSA**) by your own bluetooth sender. After that, you can enjoy the music by the bluetooth receiver. The system will turn to the normal working state if no pairing in 10 minutes.

---

## Additional information

### PRECAUTIONS

#### On Safety

- Should any solid object or liquid fall into the receiver, unplug the receiver and have it checked by qualified personnel before operating it any further.

#### On Power Sources

- Before operating the system, check that the operating voltage is identical with your local power supply.
- The operating voltage is indicated on the back of the speakers.
- As long as the unit is not removed from the wall outlet, the unit will not be disconnected from the AC power source (main) even if the unit itself has been turned off.
- If you are not going to use the system for a long time, be sure to disconnect the system from the wall outlet. To disconnect the AC power cord, disconnect by grasping the plug itself; never pull the cord.
- One contact prong of the plug is wider than the other for safety purposes, which will fit into the wall outlet only one way. If you are unable to insert the plug fully into the outlet, contact your dealer.
- The AC power cord should only be changed at a qualified service shop.

#### On Heat Buildup

- Although the system heats up during operation, this is not a malfunction. If you continuously use this system at a large volume, the receiver temperature on top, side and bottom may rise considerably. To avoid burning yourself, do not touch the receiver.

#### On Placement

- Place the system in a location with adequate ventilation to prevent heat buildup and to prolong the life of the system.
- Do not place the system near heat sources or in a place subject to direct sunlight, excessive dust, or mechanical shock.
- Do not place anything on top of the receiver that might block the ventilation holes and cause malfunctions.
- Do not place the system near equipments such as a TV, VCR, or tape deck. (If the system is being used in combination with a TV, VCR or tape deck, and is placed too close to such equipment, noise may occur and picture quality may suffer. Especially, when using an indoor antenna).
- Use caution when placing the system or speakers on surfaces that have been specially treated (with wax, oil, polish, etc.) as staining or discoloration of the surface may result.

#### On Operation

- Before connecting other components, be sure to turn off and unplug the system.
- The center speaker is magnetically shielded to allow it to be installed near a TV set. However, color irregularities may still be observed on certain types of TV sets.
- As the front speakers, center speaker and the subwoofer are not magnetically shielded, we recommend that you place them slightly further away from the TV set.
- If color irregularity is observed, turn off the TV set then turn it on again after 15 to 30 minutes.

---

- If color irregularity is observed again, then place the speaker further away from the TV set.

- If howling occurs, reposition the speakers or turn down the volume on the receiver.

**On Cleaning**

- Clean the receiver panel, and controls with a soft cloth slightly moistened with mild detergent solution. Do not use any type of abrasive pad, scouring powder, or solvent, such as alcohol or benzene.

- If you have any questions or problems concerning your system, please consult your nearest PyleUSA dealer.

## TROUBLE SHOOTING

Use this chart to help you solve operational problems. If there are any problems that can not be solved, please contact **PyleUSA Service Center**.

Problem	Possible Reasons	Solutions
<b>Can't get through power supply</b>	The plug is not inserted properly.	Check power supply and plug.
	The socket has no power.	Check socket and power supply.
<b>Display can't be turned on</b>	The fuse is broken.	Replace the fuse.
	Have not pressed "POWER" button.	Press the "POWER" button again.
<b>No sound at all</b>	Incorrect selection of input signal.	Read the manual carefully again.
	The wire and lead are not connected correctly.	Check the wire and lead.
	The mute state is turned on.	Turn off the mute state.
	Sound source machine is not powered.	Turn on the power of sound source.
<b>Neither of the main channels have sound</b>	The speaker line is not connected properly.	Read the manual.
	The signal plug is connected incorrectly or lines are short-circuited.	Check the connection of the signal plug.
<b>Center channel has no sound.</b>	The speaker line is not connected properly.	Read the manual.
	Mode is not set properly.	Mode should be set that the center channel has output.
<b>Side Surround channels have no sound</b>	The speaker line is not connected properly.	Read page 3 of the manual.
	Mode is not set properly.	Mode should be set that the surround channel has output, for example, 5.1 channel.
<b>The sound of surround channel is low</b>	The sensitivity of speakers is too low.	
	The volume is set too low.	Reset volume.
	The input signal is STEREO.	Change to 5.1 channel.
<b>The sound of center channel is low.</b>	The sensitivity of speakers is too low.	
	The volume is set too low.	Reset volume.
<b>Sound from speakers is out of order</b>	Speakers are located inappropriately.	Read the manual.
	The lines are not connected properly or the Disc is defective.	
<b>No sound when you choose HDMI input</b>	Sound source machine is not powered.	Turn on the power of sound source.
	The HDMI line is not connected properly.	Read the manual.
	Sound source machine doesn't set the HDMI out mode	Set the Sound source machine to HDMI out mode
<b>Can't operate or display normally</b>	Affected by exterior strong disturbance.	Turn off first then turn on again.
		Avoid direct sunlight/heat.

<b>Radio</b>		
<b>The FM reception is poor.</b>	Need outdoor antenna.	Stretch the FM antenna of the receiver in the rear panel. But please don't connect the receiver to an outdoor FM antenna on raining days.
<b>Radio stations cannot be tuned in.</b>	Check that the antennas are connected securely.	Adjust the antennas and connect an external antenna, if necessary.
	The signal strength of the stations is too weak (when tuning in with automatic tuning).	Adjust manually
	No stations have been preset or the preset stations have been cleared (tuning by scanning preset stations).	Make sure you set the tuning interval correctly.
<b>The remote control does not function.</b>	Obstacles exist between the remote and the receiver.	Remove any obstacles in the path between the remote and the receiver.
	The remote batteries are weak.	Replace all batteries in the remote control with new ones.
	Incorrect input selection on the remote control.	Make sure you select the correct input on the remote control.
<b>Error messages</b>	If appears a message, there may be a malfunction.	You can check the condition of the system by the message.
	Should any problems persist.	Consult your nearest PyleUSA dealer.
<b>Protect</b>	Irregular current is output to the speakers. The receiver will automatically turn off after a few seconds.	Check the speaker connection then turn on the power again.
<b>If you are unable to remedy the problem using the troubleshooting guide</b>		Clearing the receiver's memory may remedy the problem. Note that all memorized settings will be reset to their initial settings on the receiver.
<b>If the problem persist</b>		Take the complete appliance to the nearest PyleUSA dealer for advice.

## SPECIFICATIONS

### Powered Home Theater PT589BT

Functions	Specifications
Bluetooth	Bluetooth input
AUX1,AUX2	AUX input
FM	FM built-in
HDMI1,HDMI2	High definition multimedia interface input
HDMI OUT	High definition multimedia interface output
Magnetically Shielded	Yes
Display	VFD display
Remote Control	Full function remote control
Adjustment	Every channel adjusts separately
Output Power	Front 400W-PEAK x2
	Center 400W-PEAK x1
	Surround 400W-PEAK x2
	Subwoofer 500W-PEAK x1
Drive Unit	Satellite: 2.5 inch
	Subwoofer: 10 inch
Frequency Response	Satellite: 150Hz-20kHz
	Subwoofer: 40Hz-330Hz
S/N	85dB
THD	0.1%
Box Material	Satellite: plastic
	Subwoofer: wooden
Size	Subwoofer: 415 x 380 x 300mm
	L, R channel: 80 x 120 x 160mm
	Surround channel: 80 x 120 x 160mm
	Center channel: 235 x 120 x 80mm
Weight	N.W.: 28.0lbs
	G.W.: 35.1lbs
Finishes	Black

PyleUSA AV receivers patent pending technologies are for the world's finest music and home theater systems. All models patent pending. All product titles, publisher's names, artwork, logos and associated images are the trademarks and/or copyright material of their respective owners. All rights reserved. Suggested prices don't represent a bonafide selling price in the metro trading area. Model number, specifications and prices are subject to change without notice.