



WWW.PYLEAUDIO.COM

IMPORTANT: PACK CAREFULLY IN ORIGINAL CARTON IF POSSIBLE. WE ARE NOT RESPONSIBLE FOR DAMAGE INCURRED IN RETURNING ITEMS FOR REPAIR. A LETTER STATING YOUR EXACT STREET ADDRESS, DAYTIME PHONE NUMBER, AND THE PROBLEM YOU ARE EXPERIENCING SHOULD BE INCLUDED. YOU MUST ALSO ENCLOSE A COPY OF THE ORIGINAL RECEIPT A SPROOF OF DATE OF PURCHASE

PYLE SERVICE CENTER
1600 63RD STREET
BROOKLYN, NY 11204
1-800-444-5671



PT730U/PT930U

Professional Public Address Amplifier w/70V/
100V Output & MIC Talkover
w/ LCD Display / ID3 TAG Function / MP3 Player



www.pyleaudio.com

OWNER'S MANUAL

Welcome

A personal welcome to you from the management and employees of **PYLE**

All of the co-workers here at **PYLE** are dedicated to providing excellent products with inherently good value, and we are delighted you have purchased one of our products.

We sincerely trust this product will provide years of satisfactory service, but if anything is not to your complete satisfaction, we will endeavor to make things right.

Welcome to **PYLE**, and thank you for becoming part of our worldwide extended family!

Unpacking

Although your **PT730U/PT930U** is neither complicated nor difficult to operate, we recommend you take a few minutes to read this brief manual and familiarize yourself with the important information regarding product features, setup and operation.

As with most electronic devices, we strongly recommend you retain the original packaging. In the unlikely event the product must be returned for servicing, the original packaging (or reasonable equivalent) is required.

Installation

Environment

Never place this product in an environment which could alter its performance or reduce its service life. Such environments usually include high levels of heat, dust, moisture, and vibration.

IMPORTANT SAFETY INSTRUCTIONS

1. Read these instructions.
2. Keep these instructions.
3. Heed all warnings.
4. Follow all instructions.
5. Do not use this apparatus near water.
6. Clean only with dry cloth.
7. Do not block any ventilation openings. Install in accordance with the manufacturer's instructions.
8. Do not install near any heat sources such as radiators, heat registers, stoves, or other apparatus (including amplifiers) that produce heat.
9. Do not defeat the safety purpose of the polarized or grounding-type plug. A polarized plug has two blades with one wider than the other. A grounding type plug has two blades and a third grounding prong. The wide blade or the third prong are provided for your safety. If the provided plug does not fit into your outlet, consult an electrician for replacement of the obsolete outlet.
10. Protect the power cord from being walked on or pinched particularly at plugs, convenience receptacles, and the point where they exit from the apparatus.
11. Only use attachments/accessories specified by the manufacturer.
12. Use only with the cart, stand, tripod, bracket, or table specified by the manufacturer, or sold with the apparatus. When a cart is used, use caution when moving the cart/apparatus combination to avoid injury from tip-over.
13. Unplug this apparatus during lightning storms or when unused for long periods of time.
14. Refer all servicing to qualified service personnel. Servicing is required when the apparatus has been damaged in any way, such as power-supply cord or plug is damaged, liquid has been spilled or objects have fallen into the apparatus, the apparatus has been exposed to rain or moisture, does not operate normally, or has been dropped.



This symbol is intended to alert the user to the presence of uninsulated "dangerous voltage" within the product's enclosure that may be of sufficient magnitude to constitute a risk of electric shock to persons.



This symbol is intended to alert the user to the presence of important operation and maintenance (servicing) instructions in the literature accompanying the appliance.

Caution: To prevent electric shock do not use this (polarized) plug with an extension cord, receptacle or other outlet unless the blades can be fully inserted to prevent blade exposure.

Attentions: Pour prévenir les chocs électriques ne pas utiliser cette fiche polarisée avec un prolongateur, une prise de courant ou une autre sortie de courant, sauf si les lames peuvent être insérées à fond sans en laisser aucune partie à découvert.

WARNING

To prevent fire or shock hazard, do not expose the unit to rain or moisture.

*WARNING FOR YOUR PROTECTION PLEASE READ THE FOLLOWING-WATER AND MOISTURE: Unit should not be used near water(e.g. near a bathtub, washbowl, kitchen sink, laundry tub, in a wet basement, or near a swimming pool, etc). Care should be taken so that objects do not fall and liquids are not spilled into the enclosure through openings.

*CLASS 2 WIRING (Adjacent to speaker terminal): The speaker output of this apparatus can exceed 10 Watts and could be a shock injury. Connection to speakers should be performed by a skilled person.

*Do not install this equipment in a confined space such as a book case or similar unit.

*This apparatus shall not be exposed to dripping or splashing and no objects filled with liquids, such as vases, shall be placed on the apparatus.

*This apparatus shall be connected to a mains socket outlet with a protective earthing connection.

*It has heed to be easy to disconnect the device. To disconnect the device from power, separate AC input cable from inlet or unplug the AC Cord.

CAUTION

*These servicing instructions are for use by qualified service personnel only. To reduce the risk of electric shock, do not perform any servicing other than that contained in the operating instructions unless you are qualified to do so.

NOTE

*This equipment has been tested and found to comply with the limits for a Class A digital device, pursuant to Part 15 of the FCC Rules. These limits are designed to provide reasonable protection against harmful interference when the equipment is operated in a commercial environment. This equipment generates, uses, and can radiate radio frequency energy and, if not installed and used in accordance with the instruction manual, may cause harmful interference to radio communications. Operation of this equipment in a residential area is likely to cause harmful interference in which case the user will be required to correct the interference at his own expense.

Features :

- *A public address amplifier with rated output of 150W/300W.
- *Supply power by 115V/230V switch.
- *Various input control function: control the each input channel level using the sound control volume of input as MIC1, MIC2, MIC3, MIC-4, MIC-5, AUX-1 and AUX-2.
- *Bass and Treble tone control.
- *Speaker selector: speaker selector switches are provided to enable you to select 4 speakers individually or totally.
- *Announcement CHIME & Siren function.
- *5-dot LED output level indicators
- *USB-MP3 player & LCD display function (MP3, WAV, WMA file format support)
- * Accessories One detachable AC power cord and 3.5mm audio cable are provided for use with this product.

Operation :

1. Don't connect the AC power unit step 4.
The AC mains POWER switch should be in the OFF position.
2. Adjust the MASTER and all INPUT volume controls of the MIN position (turn counterclockwise).
3. Adjust the tone control BASS and TREBLE to the 0dB position.
4. Connect the OUTPUTS to the speakers load according to the mode of operation determined in the previous step.
5. Depress the AC mains POWER switch to the ON position. The POWER ON indicator will illuminate.
6. The product is ready for operation, slowly increase the LEVEL control to the desired operating level. Avoid illuminating the PEAK indicator and do not apply too much power to the speakers.

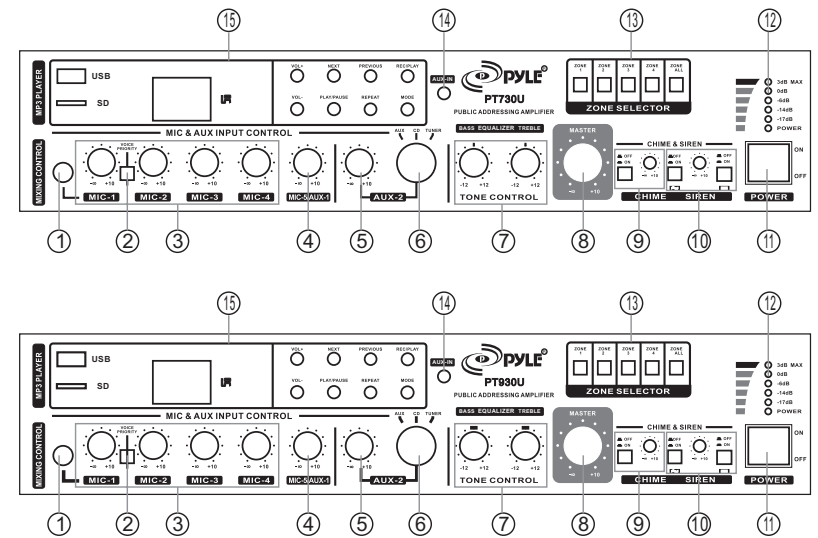

1. MIC 1 INPUT JACK

Allows you to connect up to 6. 35 type microphone, and can be used as the normal dynamic MIC input.

2. VOICE PRIORITY BUTTON

MIC talk-over function: the background music will be disappeared by pushing the button when the signal is inputted to MIC1.

3. MIC1-4 VOLUME CONTROL

Control the sound level for each of the MIC input sources.

4. MIC-5/AUX-1 VOLUME CONTROL

Control the sound level for MIC-5 or AUX-1 input sources.

5. AUX-2 VOLUME CONTROL

Connect any high level sound input sources (by 1/4" audio input, 1/8" iPod/MP3 input, and RCA audio input) such as a CD player, tape deck, or tuner to the jack.

6. AUX-2 INPUT SELECT (AUX / CD/TUNER)

Select and connect an alternative audio sound source.

7. TONE CONTROL (BASS & TREBLE)

Adjust the sound frequency to the acoustics of a performance environment.

8. MASTER

Let's you adjust the overall sound level.

9. CHIME FUNCTION

Chime on/off button switch and chime volume control

10. SIREN FUNCTION (WITH TWO EFFECTS)

Siren on/off button switch and siren volume control

11. POWER ON/OFF SWITCH

This is heavy-duty and rocker-type switch turns on the power to the amplifier. When the unit is turned on, there is a three-second delay, which reduces/eliminates the turn on transients associated with the system equipment connected to the amplifier and protects loudspeaker.

This switch makes up that one pole be cut off when power is off.

12. OUTPUT LEVEL INDICATOR AND POWER ON INDICATOR

This indicates the main output signal level relative to the related power output which is marked as 0dB

13. SPEAKER /ZONE SELECTOR

These switches are used to select output to any combination of up to four individual speakers at 100V status.

14. AUX-IN 3.5MM AUDIO INPUT

IPHONE/ MP3/SMART PHONE connect to the jack.

15. MP3 PLAYER+ USB/SD SECTION

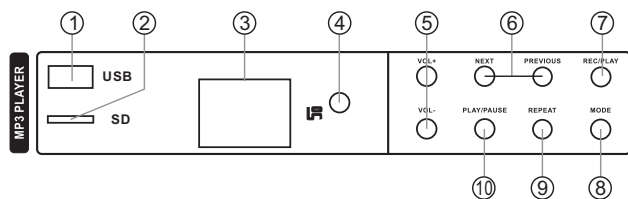

1. USB input terminal

2. SD input terminal

3. LCD display

This luxurious LCD display the MP3 function playing status and with ID3 TAG function showing music song's title and lyrics.

4. REMOTE SENSOR WINDOW

5. VOL+ & VOL- button

Increase or decrease the music volume.

6. PREVIOUS/NEXT button

Push shortly to skip the former or next song.

7. REC/PLAY button

Button switch between recording and playing model

8. MODE button

Switch selection for USB or SD player when both the USB card and SD card are available at the same time.

9. REPEAT button

Marks the start point A when being pressed once and then marks the end point B when being pressed again. The system then repeats from A to B. If a number is already present, pressing the key will add 0 to the end.

10. PLAY /PAUSE

Push it to play or push again to pause.

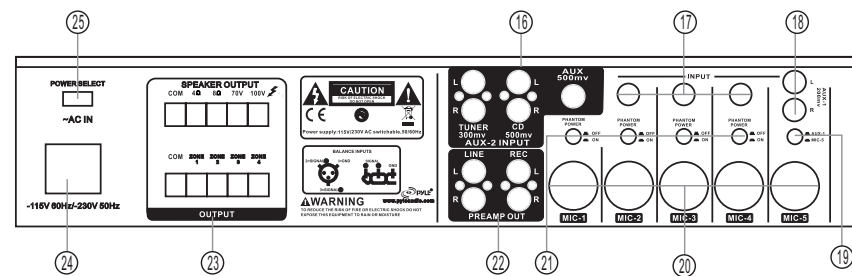

16. AUX-2 INPUT JACK (LIKE TUNER, CD, AUX INPUT)

It can be used as an extra stereo input for a stereo source such as a tape deck, CD player, or Tuner, etc.

17. MIC 2, 3, 4, UNBALANCED INPUT JACK

Unbalanced 6.35mm input jack, and can be used as the normal dynamic MIC input.

18. AUX-1 INPUT JACK

It can be used as an extra stereo input for a stereo source, too.

19. AUX-1/ MIC-5 SWITCH

20. MIC1, 2, 3, 4, 5, BALANCED INPUT JACK

Input MIC1-5 jacks are utilized to connect various external sound source devices including MIC, CD, Tuner, etc.

MIC: it can be used as the normal dynamic MIC input.

PHANTOM: it can be used as the condenser MIC input and DC 48V is supplied to the input terminal.

21. PHANTOM POWER ON/OFF SWITCH

22. PREAMP OUT

REC/LINE RCA STEREO OUTPUT JACK

23. SPEAKER PUSH-TERMINAL CONNECTORS

This terminal is for speaker wire connection, and connect the speaker whose combined impedance is equal to or higher than the rated output impedance, as shown below:

PT730U 24.5V/4Ω 35V/8Ω 70V/33Ω 100V/67Ω

PT930U 35V/4Ω 49V/8Ω 70V/17Ω 100V/34Ω

24. AC INLET/FUSE HOLDER

25. POWER SELECT

115V/60Hz and 230V/50Hz switch

Connecting Speakers

Before connecting speakers to your PT730U/930U unit, be sure to disconnect the AC power cable. Make certain that the total impedance is not less than the rated impedance indicated. For 4Ω/8Ω/70V/100V impedance speakers, connect in parallel, with the positive (+) connectors to the 4Ω/8Ω/70V/100V terminal and the negative (-) connectors to the COM terminal. And be certain that the total impedance does not less than the rated impedance.

Connect to 4Ω speaker

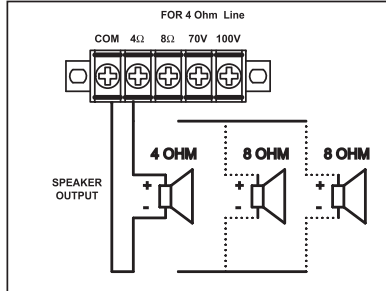

Connect to 8Ω speaker

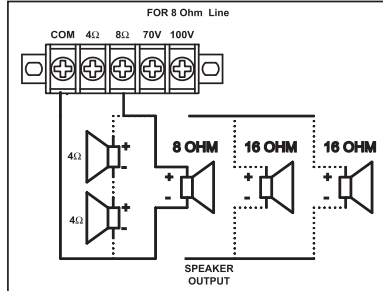

Connect to 70V speaker

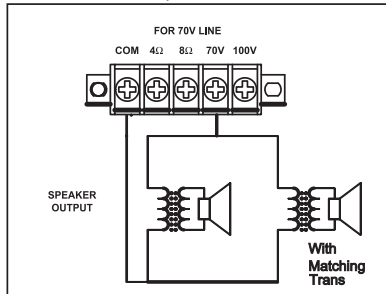

Connect to 100V speaker

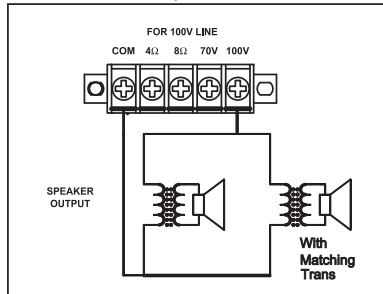

Connect to ZONE PAGE 100V line

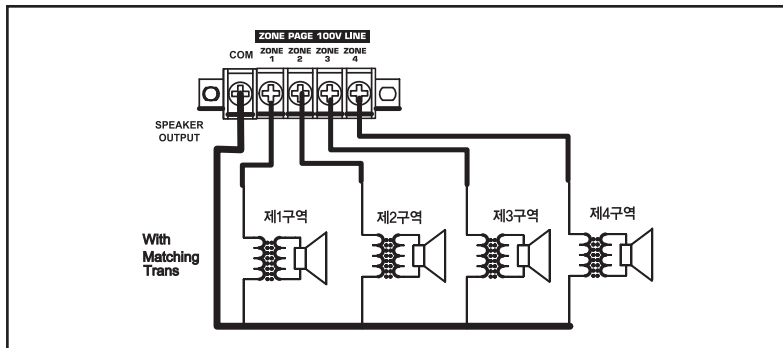

MODEL NO.:
 Rated Output (RMS)
 Frequency Response
 Signal to Noise Ratio
 T.H.D(at 1KHz Rated Output)
 Tone Controls Master

PT730U,PT930U

150W 300W
 80Hz – 20KHz
 Mic 1 – 5 : 60dB Aux : 80dB
 Less than 0.1 %
 Bass +/- 12dB at 100Kz
 Treble + - 12dB at 10KHz

Sensitivity/impedance

MIC 1~5: 2mV/600ohm,BAL
 AUX IN: 250mV/10kohm,UNBAL
 LINE IN: 250mV/10kohm,UNBAL
 REC OUT:1000mV/10kohm,UNBAL

Speaker Output/impedance

4 ohms/21.9V,
 8 ohms/30.9V,
 70V (40.8ohm)
 100V(83.3ohm)

[**USB PLAYER**]

Type

USB + MINI SD CARD PLAYER

Frequency Response

30Hz – 20KHz

General

Power Source

AC220V 60Hz

Power Consumption

360 Watts (PT730U) 480 Watts (PT930U)

FUSE

T3A(PT730U) T4A(PT930U)

MEAS (W x H x D)mm

483 x 88 x 330

WEIGHT

10 Kg(PT730U)
 12 Kg(PT930U)