

PYLE[®] PVR200

www.pyleaudio.com

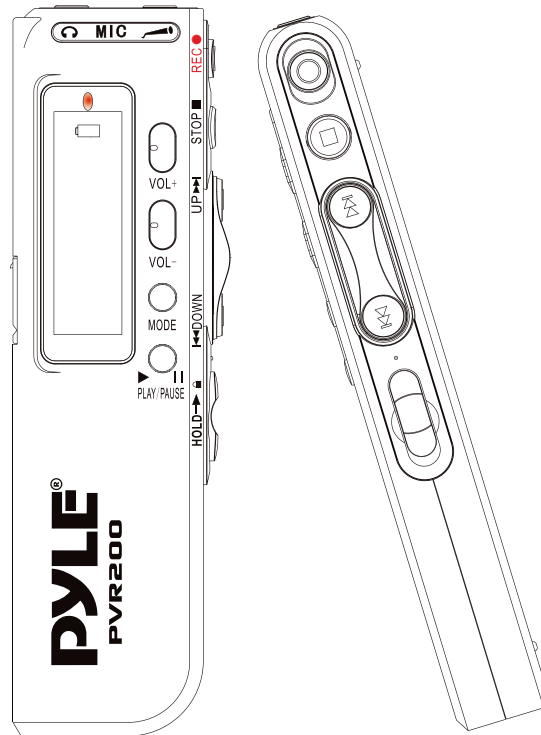

Digital Voice Recorder

User's Manual

Safety instructions

IMPORTANT SAFETY INSTRUCTIONS

Read this manual before use and keep it handy for future reference.

Precautions

To maintain optimum performance:

Do not use the unit in extreme hot , cold, dusty or high humid places.

Do not use or keep the unit in following places.

- In a high humid area, such as a bathroom or hypogeum.
- In an area exposed to direct sunlight (e.g. inside car where it becomes extreme hot).
- Near sources with strong magnetism, such as television, speaker or magnet.
- In trembly places, such as on the car dashboard or shaky shelf.

For safety

- Do not attempt to disassemble this unit.
- Avoid pins or else objects getting inside the Unit.
- Take care of it , do not throw the unit .

Attention : Do not listen with the earphones as following circs .

- listen at moderate volume in case of hearing harm.
- Do not wear the earphones while driving or cycling. It may cause traffic accident.
- You should use it with extreme caution or temporary pause in latent accident situation while walking, Jogging, etc.
- If you hear soundless, do not turn the volume up too high because the music may suddenly begin at high volume in case of hurting your ears or damaging the headphone, turn the volume control to the lowest level before starting playing back and turn it up slowly to the desired level.

Location Of Indicators

LOCATION OF INDICATORS

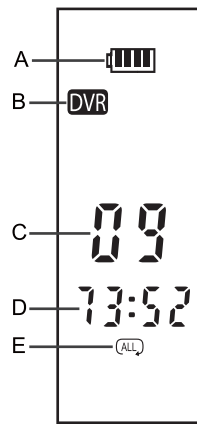

Voice mode

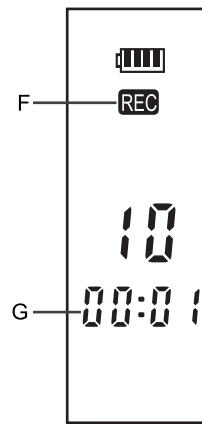

REC mode

- A. Battery indicator
- B. Voice mode indicator
- C. File number indicator
- D. Duration indicator
- E. Repeat mode indicator (ALL, (T))
- F. REC mode indicator
- G. Recording time indicator

Location Of Keys

LOCATION OF KEYS

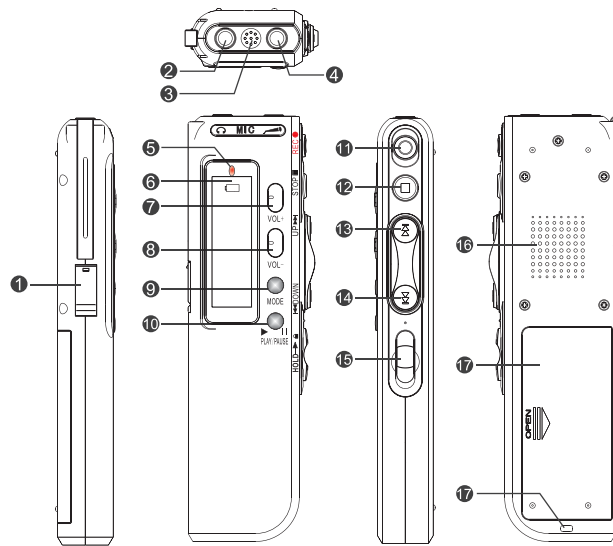

- ❶ USB Interface
- ❷ Earphone Jack
- ❸ Built-in Microphone
- ❹ Microphone Jack
- ❺ Recording LED
- ❻ LCD display
- ❼ Volume+ key
- ❽ Volume- key
- ❾ MODE key
- ❿ Play/Pause key
- ⓫ Record key
- ⓬ Stop key
- ⓭ Up key ▲
- ⓮ Down key ▼
- ⓯ Hold switch
- ⓰ Loudspeaker
- ⓱ Battery compartment
- ⓲ The rope hole

Battery Installation

It will never affect files stored in the unit to replace batteries, if you shut down the unit with normal operation.

1 Push to open the battery cover.

2 Insert 2pcs of “AAA” size batteries with correct polarity.

2 Close the battery cover.

* Once the batteries are installed, this unit will turn on automatically.

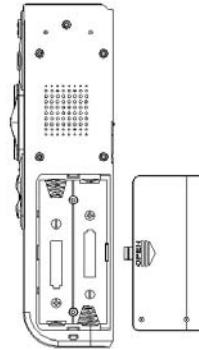

BATTERY INDICATORS

 The batteries are high level.

 The batteries are low level.

 The batteries are exhausted, the “Lo” will show on LCD, and need to charge it or replace.



BATTERY PRECAUTIONS

Follow these precautions when using batteries in this device:

1. Only use the battery with specified size and type.
2. Be sure to follow the correct polarity when installing the batteries as indicated on the battery compartment. Reversed polarity may cause damage to the device.
3. Do not mix different types of batteries together (e.g. Alkaline and Carbon-zinc) or old battery with fresh one.
4. If the device would not be used for a long period of time, remove batteries to prevent damage or harm from possible battery leakage.
5. Do not try to recharge batteries without rechargeable function, or they will overheat and rupture. (Follow battery manufacturer's directions.)
6. Never try to remove the batteries while using.

Basic Operation

To turn on/off the unit

- 1 Press and hold the PLAY/PAUSE key more than 2secs., and the red indicator will flash for one time, the "00 00", "49 95", "49 95" will show on LCD one after another, then enter into the Voice mode as right photo.
"49 95" means 4969MB(4GB) built-in memory in this unit.
- 2 Press PLAY/PAUSE key more than 2secs., and the "00 00" shows on LCD, then the LCD goes out, the unit is turned off.



HOLD function

- 1 Slide the HOLD switch up to set it on, then all keys lose function, and the "H o l d" will show for 2secs. when any key is pressed.
* It's very useful function to avoid error operation while recording or playing.
- 2 Slide the HOLD switch down to set it off, and it will recover all keys function.



VOR and recording quality mode

Before recording, you can set the VOR function according as your demand. If it is turned on and the detected volume doesn't reach the VOR level value(set by system), the recording will pause until it detects eligible volume, otherwise it will continue recording soundless section in this file .

- 1 At Voice mode, you may press VOL+ or VOL- key back and forth to set the VOR and recording quality mode.

00	01	LP	SP
VOR off	VOR on	good recording quality	better recording quality. *It'll occupy bigger space than LP mode.



Operation

Recording file

- 1 After simple function settings, you may press REC key once to start a recording, then the recording LED lights up, and the elapsed time shows on LCD.
 - * The file number is generated orderly.
 - * Whatever mode or setting state, it'll start a recording if you press REC key.
- 2 While recording, you may press REC or PLYA/PAUSE key for a pause, and press it again to continue recording.



- 3 Finish recording, just press STOP key to stop recording and save this recording file, then it'll turn to Voice mode.

Note

- * The first several minutes sound may not be recorded for activating the recorder .
- * There are two ways for recording input (Internal Mic ,External Mic).
- * It is seemly distance to be away 50mm from the sound source.



Playing the file

- 1 Select a desired file by UP or DOWN key, the file number and duration of the recording file shows on LCD
- 2 Then press PLAY/PAUSE key to play, and you may press it back and forth for a pause or continuous playing, then press STOP key to stop it.
 - * In pause, the pause time and the quality of file(s) will blink in turn.
Ex.: " F 16 " means that there are 16 recording files in this unit.
- 3 While playing, you may press UP or DOWN key to skip to playing the previous or next recording file.
- 4 You may press VOL+ or VOL- key to adjust volume while playing. "0" is minimum volume , "31" is maximum volume.
- 5 While playing, you may press and hold UP or DOWN key to run Fast Rewind or Fast Forward .
 - * For private listening, connect an earphone to Earphone jack.



Operation

Playing back recording file repeatedly

- 1 There are three modes for playing back file. While playing, press MODE key to goto setting menu, then press UP or DOWN key to select Repeat mode.

Note:

Normal playing "ALL": Playing the current file just for one time.

All repeat "ALL (ALL)": Playing all recording files repeatedly.

One repeat "ONE (ONE)": Playing the current recording file repeatedly.

* Factory setting is "ALL".

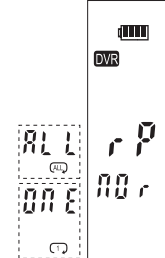

Playing back a section within a file repeatedly

- 1 While playing, press MODE key twice to goto setting menu as right photo, and the "A-" blinks, then press DOWN key once to set the start "A" within 5secs., and then the "B" blinks on LCD, it's still playing, then press DOWN key again to set the end "B" at the desired point, then this A-B section will play repeatedly for 5 times.
- 2 After 5 times playing, it'll skip to "A-" blink again, so you may set it again as your desire, or you may press MODE key to cancel.
- 3 While "A-B" section playing, you may press MODE or DOWN key to cancel and recover to initial playing state.

* While setting or playing the "A-B" section, you may always press UP key to reset it, and the "A-" will blinks again.

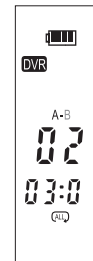

Delete file(s)

- 1 At Voice mode, press UP or DOWN key to select desired file to delete, then press and hold MODE key to skip to setting menu.
- 2 Then the "ONE" will blinks on LCD, and you may press UP or DOWN key to select "ALL" or "ONE", and then press PLAY/PAUSE key within 3secs. to confirm to delete current file or all recording files.

* Once file(s) is deleted, it can not be recovered.

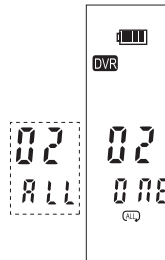

Download and upload files

Download and upload files

- 1 Connect the unit to a computer by USB cable .
- 2 Copy (recording) files to a removable disk or computer, or copy music files to your recorder according as your demand.
- 3 After finishing your operation, disconnect the unit with your PC by the Safety Remove Hardware procedure.



Specifications

SPECIFICATIONS

File Number		Max.99	
Recording time 4GB		SP	
		LP	
		68H	
Recording		Format	
		WAV	
		Sample rate	
		8KHz	
Playing		Format	
		WAV, WMA	
		Bit rate	
		SP 192kbps LP 64Kbps	
SINR		>=90dB	
Frequency Response		20Hz - 20KHz	
Memory (SD or FLASH)		Build-in memory 4GB	
USB		USB V2.0 Socket	
Jacks	MICROPHONE	Ext. Mic (D3.5mm ,Stereo)	
	EARPHONE	Earphone (D3.5mm, Stereo)	
	USB JACK	MINI 5Pin	
Loud speaker		16 ohms dynamic speaker	
Output power		Speaker	100 mW(8ohm)
		Earphone	10 mW(32ohm)
Power supply		2 x AAA (LR6) Alkaline Battery	
Power life	Recording	About 13.5h	
	Playing	About 3.5h (Earphone), 9h (Loudspeaker)	
Size		108 X 30 X 15 MM	
Weight		29.7g	

* Specifications are subject to change without notice.



IMPORTANT: Pack carefully in original package if possible. We are not responsible for damage incurred in returning items for repair. A letter stating your exact street address, daytime phone number, and the problem you are experiencing should be included. You must also enclose a copy of the original receipt as proof of date of purchase

**Brooklyn, NY 11204
(718)535-1800
Monday Through Thursday. 9AM to 5PM
Friday 9AM to 1PM Eastern.**