

SLGT48S

Small Hydroponic Grow Tent Garden

Reflective 600D Mylar with Observation Window and Floor Tray for Indoor Plant Growing

serenelife™

USER GUIDE

Features:

- Reinforced by Heavy Metal Rods, with Durable Zipper
- Double Stitching Protection to Ensure Long-Lasting Use
- Easily Observe the Plants without Stepping into Tent
- Lightweight and Velcro Design
- Removable Water-Resistant Floor Tray
- Easy to Clean or Wash
- Heavy Duty All Steel Poles
- Double Duct Port Enclosures
- Blocks all Light from Escaping
- Adjustable Vent Doors
- High-Reflectivity, Carbon Filter Belts
- Inner Tool Organizer
- Light-Proof SBS Zippers
- Effectively Improve Light Efficiency

What's in the Box:

- Tent Body
- **Metal Poles:**
 - (4) A Pole
 - (4) B Pole
 - (4) C Pole
 - (4) D Pole
 - (1) E Pole Hanging Bar Lower
 - (1) F Pole Hanging Bar Deep
 - (1) G Strengthen Pole
- (8) Triangle Connector
- (2) Filter Straps
- (1) Floor Tray
- (1) Grow tent pole shelf

Technical Specs:

- Construction Materials: 600D Canvas with Metal Poles and Corner Adapters
- Maximum Temperature: 80°C or 176°F
- Hanging Bar Weight Capacity: 44 lbs.
- Metal Push-Lock Corners: Handle Up to 90 lbs.
- Filter Straps Size: 55" -inches
- Floor Tray Size (L x W x H): 48" x 24" x 3.95" -inches
- Hanging Bar Size: 48" -inches and 24" -inches
- Pole Shelf Size (L x W x H): 4.72" x 4.72" x 2.76" -inches
- Strengthen Pole Size: 48"-inches
- Tent Body Size (L x W x H): 48" x 24" x 60" -inches

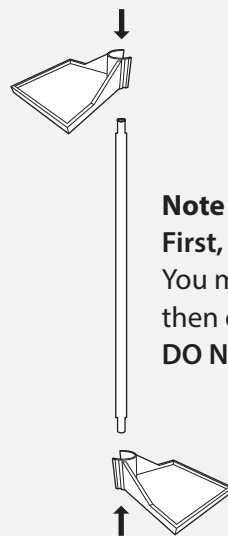

Note on **STEP 1**

First, firmly install Pole shelf on the height pole. You may attach the pole shelf from TOP or BOTTOM then drag to your desired position. **DO NOT** attach the Pole shelf in the middle.



Questions? Issues?

We are here to help!

Phone: (1) 718-535-1800

Email: support@pyleusa.com

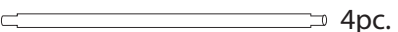
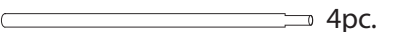
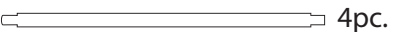
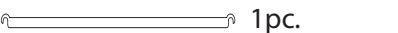
Components:

- A  4pc.
- B  4pc.
- C  4pc.
- D  4pc.
- E  1pc.
- F  1pc.
- G  1pc.

- 1. Tent
- 2. Floor Tray
- 3. Filter Straps
- 4. Corner Adapter
- 5. Grow tent pole shelf
- (A-G) Framework Support

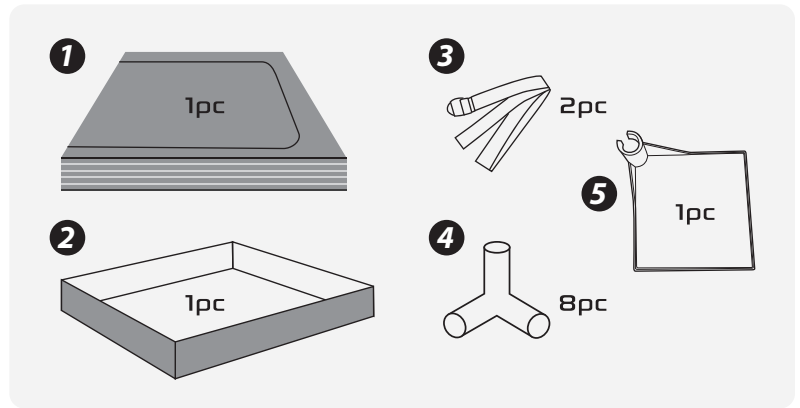

Assembly Instructions

