

PYLE

Multi Media Mobile Audio System

PLD-136

OPERATIONAL MANUAL



Welcome!

Thank you for buying this multi-media mobile audio system!

To operate the system correctly, please read the operational manual carefully before using the unit. Keep these instructions and retain this booklet for future reference.

About This Manual

This unit features a number of sophisticated functions ensuring superior operation. This manual will help you understand the functions and operations of the unit. This manual mainly explains **remote control operation**. However, in addition to those functions related with DVD/VCD/CD/MP3 operation that can only be operated by the remote control, there are also functions that can be operated by the buttons provided on the main unit.

Trouble Shooting

The following checklist can help you to solve some problems when using the unit. Please double check and make sure if the connection and the procedure of the operation are proper before using the checklist below .

Problem	Cause/Solution
No power.	<ul style="list-style-type: none"> • Check and make sure whether the fuse is blown, replace with the proper value if necessary.
A CDs cannot be loaded.	<ul style="list-style-type: none"> • A CDs is loaded in the mechanism.
Sound skips.	<ul style="list-style-type: none"> • The CDs is dirty or damaged.
No images.	<ul style="list-style-type: none"> • The Video line from main unit to the TV is not connected properly.
Images skip.	<ul style="list-style-type: none"> • Improper setting of the color system. Set the color system to "PAL" or "NTSC" according to the connected television.

Note:

If any of the problem persists after checklist had been made, consult your nearest service dealer. Never attempt to disassemble your unit by yourself.

 *Due to continuous product improvement, the operations are subject to run the model.*

Detach the Unit (for Installation Method2)

1. Remove the outer trim frame.

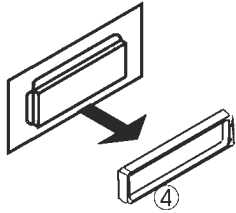

2. Insert the keys supplied with the unit at both sides of the unit as shown in figure until they click. Pulling the keys makes it possible to remove the unit from the dashboard.

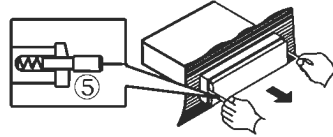

- ① Mounting Sleeve x1 ② Rear Mounting Bolt x1 ③ Harness Rubber x1 or Metallic Lath x 1
- ④ Outer Trim Frame x1 ⑤ Key x2 ⑥ Bracket

Specification

General

Power Requirement	14.4V DC (11-16V allowable)
Load Impedance	10KΩ
Max.Level Output	2V/CH
Dimensions	Approx.157 x 162 x 50 mm (d/w/h)
Mounting Dimensions	Approx.142 X 165X51 mm (d/w/h)
Weight	Approx.1.1kg

Separation 70dB(1KHz)

Distortion 0.1%

DVD Player Section

Number of channel	2 channels
Frequency Response	20Hz—20,000Hz
Dynamic Range	98dB
Signal-to-Noise Ratio	90(JIS)
Wow and Flutter	Less than measurable limit

VCD/CD Player Section

VCD Signal System	PAL/NTSC
Signal-to-noise Ratio	75dB

Note:
Due to continuous product improvement, specifications and design are subject to change without prior notice.

CONTENTS

Notes on Installation	4
Precautions	5
Wiring Connection	6
Location of Controls	7
Card Remote Control	8
Basic Operation	10
Playing a DVD	11
Playing a VCD	20
Playing a CD/MP3	22
Maintenance	24
Install the Unit	25
Specification	26
Simple Troubleshooting Guide	27

Notes on Installation

- ⊗ The unit is designed for DC 12V , negative ground operation system only. Before installing the unit, make sure your vehicle is connected to DC 12V negative ground system.
- ⊗ Be sure to connect the color coded leads according to the diagram. Incorrect connections may cause the unit to malfunction or damage the vehicle's electrical system.
- ⊗ Make sure all the connections are completely correct before turning on your unit.
- ⊗ When replacing the fuse(s), the replacement must be of the same amperage as shown on the fuse holder.
- ⊗ Do not block vents or radiator panels. Blocking them will cause heat to build up inside and may result in fire.
- ⊗ After completing the installation and beginning to play the unit,(including replacing the battery), press **RESET** button on the base with pointed object (such as ball-point pen) to set the unit to initial status.

Install the Unit

Installation Method1

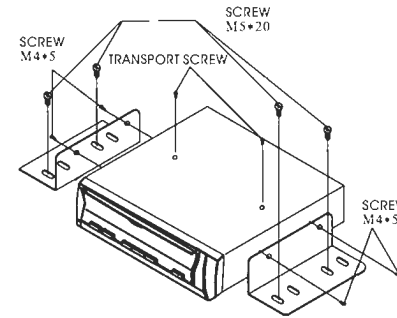

Installation Method2

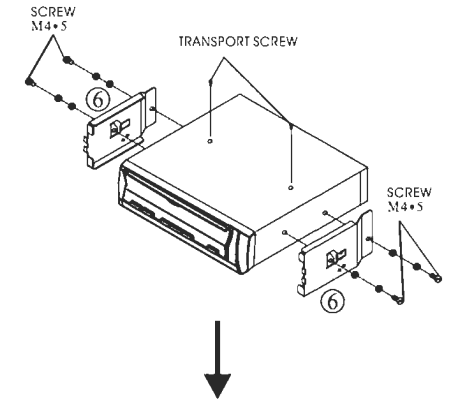

Installation Method2

	<p>Bend these claws outward for a tight fit, if necessary.</p>
<p>1 2</p> <p>3 4</p> <p>Firstly insert the main unit, then remove the sticking paper of the Outer Trim Frame, and then cover the front panel with the Outer Trim Frame. (Shown as picture)</p>	<p>Front Wall of the Cab</p> <p>To support the unit</p>

Maintenance

Replacing the Fuse

Make sure the amperage matches the specified value when replacing the fuses. If the fuse is blown, check the power connection and replace with a new one. If the same problem occurs, it would be subjected to the malfunction in-house. In such cases, please consult the nearest service dealer.

⚠ Warning

Never use the fuse with the rated amperage more than that supplied to your unit, otherwise it will damage the unit.

Replacing the Battery

When the range of the operation of the card remote control becomes short or no functions while operating. Replace the lithium battery with a new button cell (CR2025). Make sure the battery polarity before replace.

1. Gently pull out the Battery Holder while pressing the Stopper ①

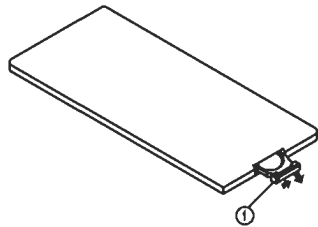

2. Put the button-type battery with mark(+) upward into the Battery Holder.

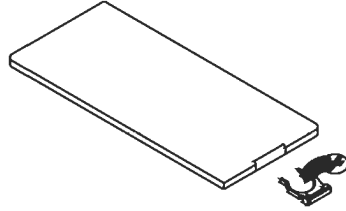

3. Insert the Battery Holder into the Remote Control.

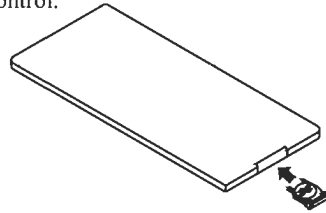

Precautions on Using Lithium Battery

- Always keep the lithium battery beyond children's reach. In case swallowed, see a doctor immediately.
- Cleaning the battery with a dry cloth, to ensure its perfect connected.
- Make sure the proper polarity when loading with the battery.
- To prevent short circuit, do not use metal tweezers to clip the battery.

⚠ Warning!

Improperly handling the battery may result in hazardous explosion. It cannot be charged, disassembled or thrown into a fire.

Precautions

☞ This unit can play the following discs only:

Type of disc	Label on the disc	Recorded material	Size of disc
DVD		Sound and moving pictures	12cm
VCD		Sound and moving pictures	12cm
CD		Sound only	12cm
MP3		Sound only	12cm

NOTE: The unit is compatible with VCD 1.0/2.0/3.0 version and DVCD disc.

☞ Do not attempt to modify the unit, modifying the unit may cause an accident.

☞ Stop the vehicle before carrying out any operation that could interfere with your driving.

☞ Do not work in extremely high or low temperature. Be sure the temperature inside the vehicle is between -10 °C and +60 °C before turning on your unit.

☞ To enjoy optimum sound and images while playing, handle the discs as follows:

— Handle the disc by its edge to keep the disc clean, and do not touch the surface.



— Do not use your CDs with paste residue or ink attached.



— Do not use CDs with labels or stickers attached, which may leave a sticky residue while beginning to peel off. (Shown as the picture)

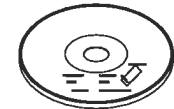

— Clean the discs with an optional cleaning cloth. Wipe each disc from the center out. (Shown as the picture)



Wiring Connection

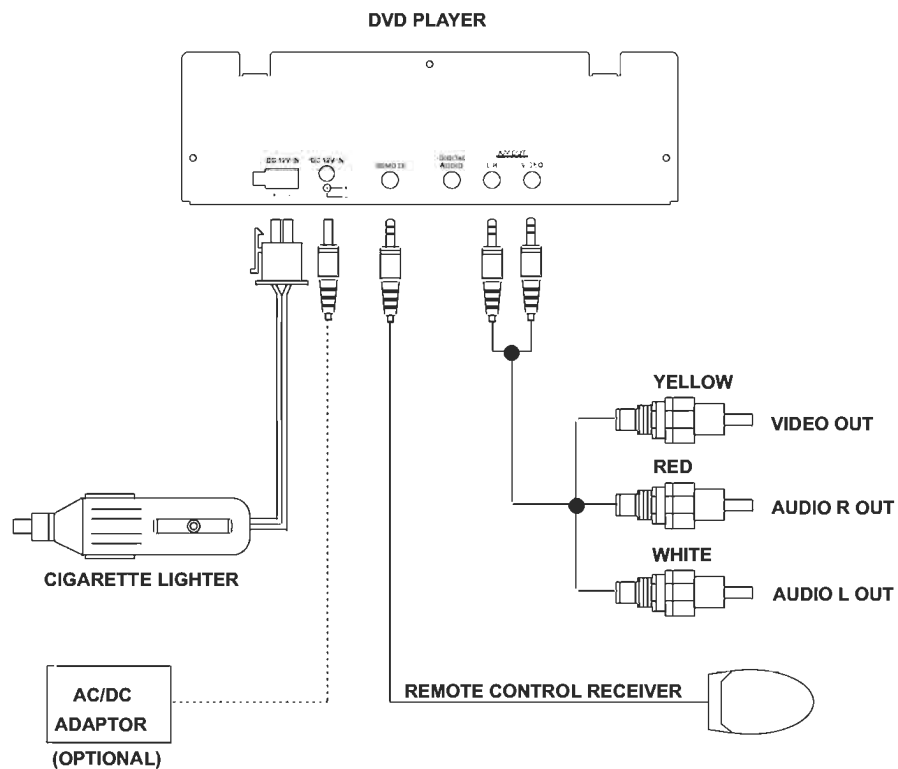

3. Repeat Playing

Press **[9]** **REPEAT** button to replay the current track; press it again to cancel this function.

Note:

* This function can only be operated on the card remote control.

4. Program Playing

During CD, MP3 status, you can set the program order to play.

You can follow the steps as below:
During CD, MP3 playback, the screen will show the picture as the following, press **[6]** button to set program order. For example: you choose your favorite track and then press **[6]** button to confirm the program order. (**[+]** add track, **[+]** add all, **[−]** delete track, **[−]** delete all.

Note:

* This function can only be operated on the card remote control.

5. CD/MP3 Menu Mode

* Insert a CD/MP3 disc, TFT shows the picture as following :

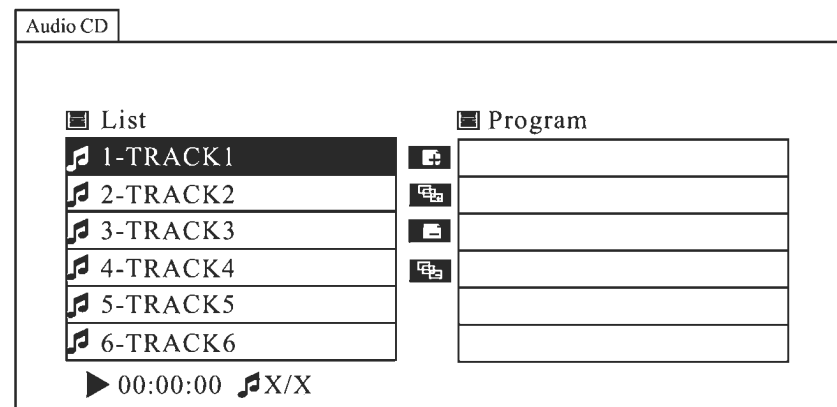

Playing a CD/MP3

1. CD/MP3 Menu Mode

Insert a CD/MP3 disc, the display will show the picture as shown on the next page.

On this picture, the left menu is the list menu, the right is the program menu.

You can press **[14] NUMBER BUTTON** to select tracks.

If you'd like to select director or tracks quickly, please press **[6] [◀][▶][▼][▲]** to select tracks as desired, and then confirm by pressing **[6] ENTER**.

Note:

* This function can only be operated on the card remote control.

2. Fast Forward/Reverse

Press **[8] ◀** button to skip reverse to the previous chapter; press **[3] ▶** button to skip forward to the next chapter.

Note:

* Pressing **[3]** or **[4]** button on the head unit performs the same operation separately.

Press **[10] ◀◀** or **[12] ▶▶** button to perform fast reverse or forward separately. Each time the button is pressed, the speed of fast reverse/forward changes as follows:

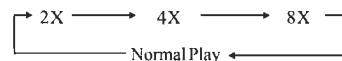

Note:

* This function can only be operated on the card remote control.

Location of the Controls

Front Panel

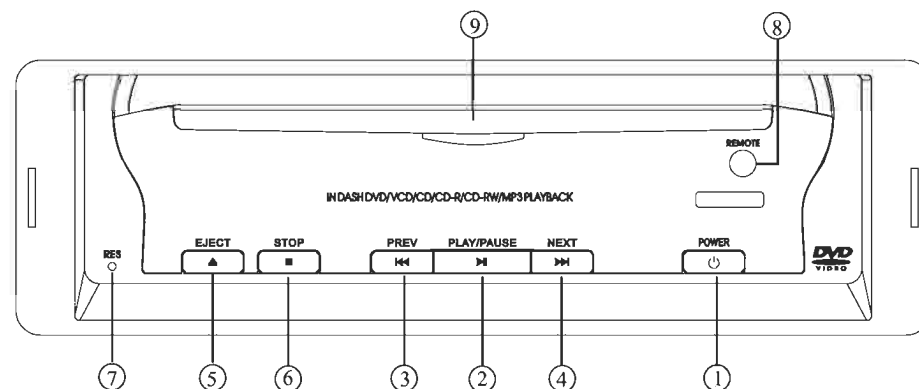

- | | |
|---|--|
| ① POWER
Press to turn on or turn off the unit. | ⑤ EJECT
Press to eject the disc. |
| ② PLAY/PAUSE
Press to switch sequentially between playback and pause; during stop mode, you can also press to resume to playback. | ⑥ STOP
Press to stop the playback. |
| ③ PREV
Press to play the previous track. | ⑦ RESET
Press to set the unit to initial status. |
| ④ NEXT
Press to play the next track. | ⑧ REMOTE
Remote control receptor. |
| | ⑨ DISC LOADING SLOT |

Card Remote Control

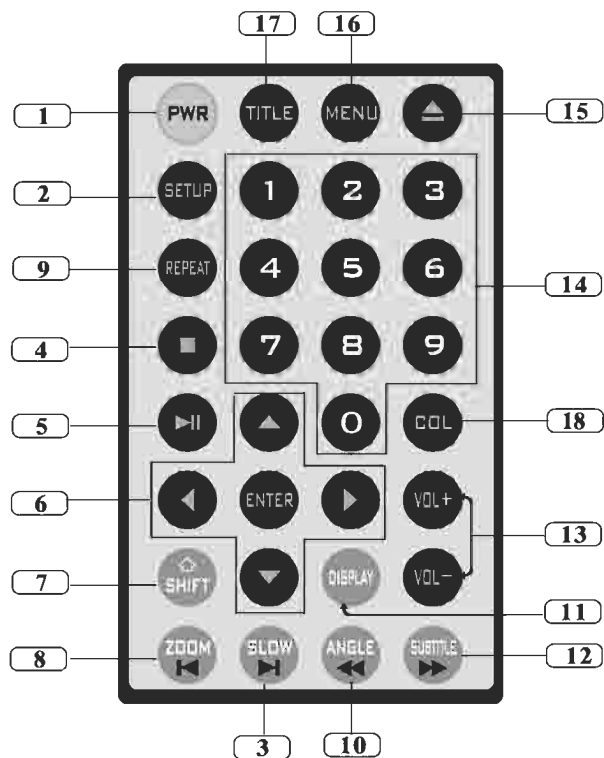

Tips:

For more information as to replacing battery, please refer to “*Replacing the Battery*” on page 24.

5. Number Buttons

During VCD (PBC OFF) mode, you can select any track directly by using (14) **Number Buttons**. For example, if you need the 15th track, you can firstly press **Button 1** and then press **Button 5 in 3 minutes**.

Note:

* This function can only be operated on the card remote control.

6. Slow Motion Playback

During VCD mode, firstly press (7) shift then press (3) **SLOW** button to slow forward. Each time the button is pressed, the speed of slow forward changes as follow:

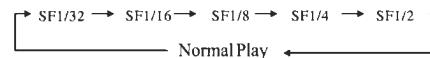

Note:

* This function can only be operated on the card remote control.

7. Increase Picture Size

During VCD mode, first press (7) **SHIFT** button, then press (8) **ZOOM** button to increase the size of picture. There are 2 sizes, each press increase the size until the maximum size is reached:

400% → 1600%

Note:

* This function can only be operated on the remote control.

8. PBC (Playback Control) Function

During VCD mode, pressing (17) **TITLE** button can activate PBC function. TFT shows “PBC ON”, and the title menu appears on TFT. You can select tracks by using (14) **Number Buttons**. Press **TITLE** button again to withdraw PBC function.

Notes:

- * This function can only be operated on the card remote control.
- * PBC playing confirms to version 2.0 of VCD disc only.

Playing a VCD

1. Fast Forward/Reverse Previous/Next Chapter

During VCD mode, press **(8)** **◀** button to skip reverse to the previous chapter, press **(3)** **▶** button to skip forward to the next chapter.

Note:

* Pressing **(3)** or **(4)** button on the head unit performs the same operation separately.

During VCD mode, press **(10)** **◀◀** or **(12)** **▶▶** button to perform fast reverse or forward separately. Each time the button is pressed, the speed of fast reverse/forward changes as follows:

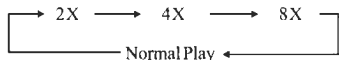

Note:

* This function can only be operated on the card remote control.

2. Repeat Playing

Press **(9)** **REPEAT** button to replay the current track; then press it once again to cancel this function..

Notes:

* This function can only be operated on the card remote control.

3. On-Screen Display

During VCD mode, press **(11)** **DISPLAY** button, TFT shows *single elapsed time*.

Note:

* This function can only be operated on the card remote control.

4. Setting Playback Time

During playback mode, press **(11)** **DISPLAY** button, TFT shows the control menu. Press **◆** to select the time display, then press **ENTER**, TFT shows --:--:--. Input your desired time by using number buttons. For example: input 01:20:00, the disc will be played from the point of eightieth minute.

Note:

* This function can only be operated on the card remote control.

(1) PWR(POWER)

Press to turn on or turn off the unit.

(2) SETUP

During DVD playback mode, press to display system setting menu, user could select some relative constant parameters.

(3) SLOW and ▶

Press to slow forward or reverse during playback.

Press **▶** to play the next track.

(4) ■ STOP

Press to stop the playback

(5) ▶|| PLAY/PAUSE

Press to switch sequentially between playback and pause; during stop mode, press to resume to playback.

(6) [◀][▶][▲][▼][ENTER]

In the system setting menu, press [◀][▶][▲][▼] to move cursor upward, downward, leftward or rightward, and then press [ENTER] to execute the entering or the selected item.

(7) SHIFT

When shift function is activated, press the buttons which have two function signals on them, the upper function is valid.

(8) ZOOM and ◀

Press **ZOOM** to make the picture increase in size;
Press **◀** to play the previous track.

(9) REPEAT

Press **REPEAT** to repeat playback;

(10) ANGLE and ◀◀

Press **ANGLE** to change the viewing angle during DVD playback.
Press **◀◀** to perform faster reverse during playback.

(11) DISPLAY

During DVD, VCD mode, Press **DISPLAY** will show the relative menu.

(12) SUBTITLE and ▶▶

Press **SUBTITLE** to change the subtitle language during DVD playback;
Press **▶▶** to perform faster forward during playback.

(13) VOL+/VOL-

Press to increase or decrease volume level.

(14) NUMBER BUTTON

Press to select track, or chapter.

(15) ▲

Press to eject the disc.

(16) MENU

During DVD mode, press to return to the main page of menu.

(17) TITLE

During DVD mode, press to return to the main page of the title menu; during VCD mode, press to active PBC (Playback Control) function.

(18) COL

Press this button to adjust the brightness and contrast and sharpness (saturation).

Basic Operation

1. Reset the Unit

When operating the unit for the first time or after replacing the car battery, you must reset the unit.

Press **RES** button on the base with pointed object (such as ball-point pen) to set the unit to initial status.

- Notes:
- * This function can only be operated on the card remote control.
 - * Pressing **RES** button will erase some memorized functions.

2. Turn the Unit On/Off

Press **PWR** button to turn on the unit, press it again to turn off the unit.

- Notes:
- * Pressing **POWER** button on the head unit performs the same operation.
 - * When the unit is turned on, insert a disc, the disc will be played automatically.

3. Volume Control

Press **VOL+** button to increase the sound level and press **VOL-** button to decrease the sound level.

- Note:
- * This function can only be operated on the card remote control.

4. Pause the Playback

During playback mode, press **▶||** button to switch between playback and pause; during stop mode, press it to resume to normal playback.

- Note:
- * Pressing **▶||** button on the head unit performs the same operation.

5. Shift Function

Press **SHIFT** button, shift function is activated, TFT shows "◆". Then press the button which have two function signals on it, the upper function is valid; then press **SHIFT** button once more, TFT will no "◆", the lower function is valid.

- Notes:
- * This function can only be operated on the card remote control.
 - * After shift function is activated, this function will remain permanently and the "◆" remain on screen unless press other button.

6. Stop the Playback

Press **■** button to stop the playback.

- Note:
- * Press **■** button on the head unit performs the same operation.

7. Eject a Disc

Pressing **EJECT** on the head unit can eject the disc.

- Note:
- * Press **15** button on the remote control performs the same function.

8. Number Buttons

During playback mode, press **14** button to select tracks, press "1" to select the 1st track, press "1" and "5" continuously within 3s to select the 15th track, by analogy.

- Note:
- * This function can only be operated on the card remote control.

9. Color Adjust

Press **COL**, the press **6** to adjust the BRIGHTNESS, CONTRAST, SHARPNESS, press ENTER to enter.

- Note:
- * This function can only be operated on the card remote control.

---OTHERS---

[Press ▷]

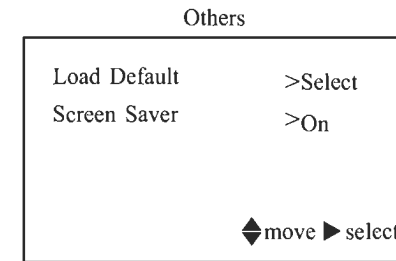

[Press ▽]

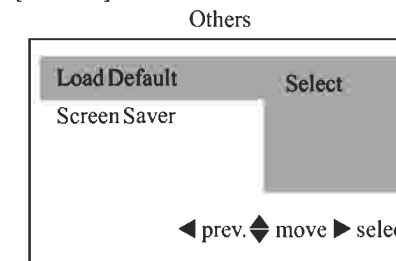

Note: This load default is no function in menu language.

[Press ▽]

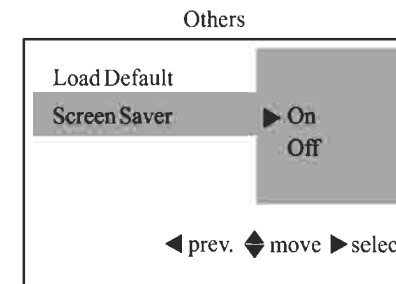

Note: The same operation with language setup.

---Preferences page---

PARENTAL

[Press ▷]

Locked

Rating	>Unlock
Password	>****
Country Code	>US

◄ move ► select

[Press ▽]

Locked

Rating	Unlock
Password	8 (adult)
Country Code	7
	6
	5
	4
	3
	2
	1 (kids)

◄ prev. ◄ move ► select

[Press ▽]

Locked

Rating	
Password	change
Country Code	

◄ prev. ◄ move ► select

[Press ▽]

Locked

Rating	
Password	
Country Code	US

◄ prev. ◄ move ► select

*: PASSWORD: The default password is 8888. If you want to change the password, you have to input the old one first, then input the new one.

Note: The same operation with the language setup.

Playing a DVD

1. Slow Motion Playback

During playback mode, press (3) SLOW button to slow forward. Each time the button is pressed, the speed of slow forward changes as following:

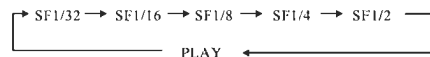

Note:

* This function can only be operated on the card remote control.

2. Fast Forward/Reverse Previous/Next Chapter

During playback mode, press (8) ◀ button to skip reverse to the previous chapter, press (3) ▶ button to skip forward to the next chapter.

Note:

* Pressing (3) or (4) on the head unit performs the same operation separately.

During playback mode, press (10) ◀◀ or (12) ▶▶ button to perform fast reverse or forward separately. Each time the button is pressed, the speed of fast reverse or forward changes as following:

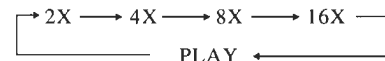

Note:

* This function can only be operated on the card remote control.

3. Setting Playback Time

During playback mode, press (11) DISPLAY button, TFT shows the control menu. Press ◄ to select the time display, then press ENTER, TFT shows --:--:--. Input your desired time by using number buttons. For example: input 01:20:00, the disc will be played from the point of eightieth minute.

Note:

* This function can only be operated on the card remote control.

4. Menu Selecting

■ During playback mode, press (16) MENU button can go to the root menu of the disc. TFT shows all the chapters of the disc, you can use (6) or (14) button to select desired chapter.

■ During playback mode, press (17) TITLE button can go to the title menu of the disc. TFT shows all the titles of the disc, you can use (6) or (14) button to select desired title.

Note:

* This function can only be operated on the card remote control.

5. Increase Picture Size

First press **[7] SHIFT** button, then press **[8] ZOOM** button to increase the size of picture. There are 2 sizes, each press increase the size until the maximum size is reached:

400% → 1600%

Note:

* This function can only be operated on the remote control.

6. Repeat Playing

Press **[9] REPEAT** button to replay the current track; then press it once again to cancel this function..

Notes:

* This function can only be operated on the remote control.

7. On-screen Display

Press **[11] DISPLAY** button, TFT shows *current chapter and title, audio, subtitle, angle, sound.*

Note:

* This function can only be operated on the remote control.

8. Changing the Audio Language (Multi-audio)

DVD can provide audio playback with different language. With DVD featuring multi-audio recordings, you can press **[11] DISPLAY** button to switch between language and audio systems. Selection options switch as follows:

AUDIO 1 — AUDIO 2 — AUDIO 3

Notes:

- * This function can only be operated on the card remote control.
- * This function only operates with DVD featuring multi-audio recordings.
- * The number in the “(2)” mark on a DVD's package indicates the number of recorded languages/audio systems.
- * During VCD mode, you can press **AUDIO** to select left channel、right channel or stereo channel.

---Preferences page---

AUDIO SETUP

Example showing how to set audio output:

[Press ▷]

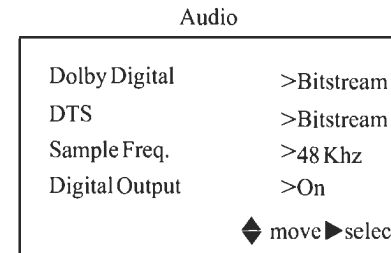

[Press▽]

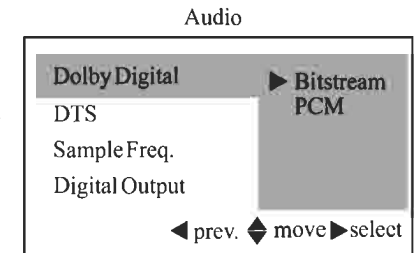

[Press▽]

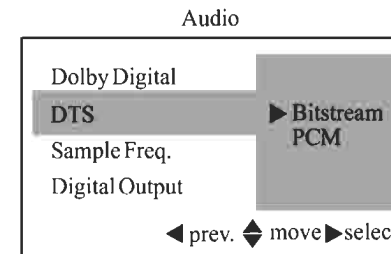

[Press▽]

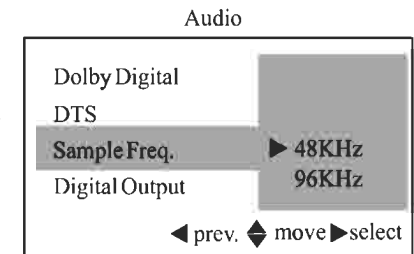

[Press▽]

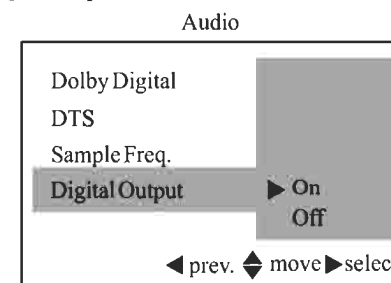

Note: The same operation with the language setup.

---Preferences page---

TV Type Example showing how to set type

(1. Press \triangleright)

DISPLAY

TV Aspect	>16: 9
Display Mode	>widescreen
TV Output	>Auto

◆move ▶select

→

(2. Press ∇)

DISPLAY

TV Aspect	4: 3
Display Mode	▶16: 9
TV Output	

◀Prev. ◆move ▶select

Note: The same operation with the language setup.

During TV Aspect is 4;3, you can setup Display Mode.

(1. Press ∇)

DISPLAY

TV Aspect	
Display Mode	▶ Letter Box
TV Output	PanScan

◀Prev. ◆move ▶select

→

(2. Press ∇)

DISPLAY

TV Aspect	
Display Mode	▶ Auto
TV Output	PAL NTSC

◀Prev. ◆move ▶select

Note: The same operation with the language setup.

9. Changing the Subtitle Language (Multi-subtitle)

With DVD featuring multi-subtitle recordings. During playback mode, firstly press $\boxed{7}$ **Shift**, then press $\boxed{12}$ **subtitle** button to switch between subtitle languages. Selection options switch as follows:

Subtitles 1 — Subtitles 2 — Subtitles 3 — Subtitles OFF

Notes:

- * This function can only be operated on the card remote control.
- * This function only operates with DVD featuring multi-subtitle recordings.
- * The number in the “ $\boxed{2}$ ” mark on a DVD's package indicates the number of recorded subtitle languages.

10. Changing the View Angle

With DVD featuring multi-angle (scenes shot from multiple angles) recordings, you can press $\boxed{11}$ **DISPLAY** button to select **ANGLE** or press $\boxed{10}$ **ANGLE** button to switch among viewing angles during playback. Selection options switch as follows:

ANGLE 1 — ANGLE 2 — ANGLE 3

Notes:

- * This function can only be operated on the card remote control.
- * This function only operates with DVD featuring multi-angle recordings.
- * The “ $\boxed{3}$ ” mark on a DVD's package indicates it features multi-angle scenes. The number in the “ $\boxed{3}$ ” mark indicates the number of angles from which scenes were shot.
- * You cannot switch angles during slow motion playback.
- * If you press **ANGLE** during fast forward/reverse or pause, fast forward/reverse or pause is cancelled and normal playback resumes but the viewing angle does not change.

11. 3D

During playback mode, press $\boxed{11}$ **DISPLAY** to select the **SOUND**, you can setup the 3D.

12. Setup Menu

During playback mode, press $\boxed{2}$ **SETUP** button, the screen will display system setting picture, you can select some relative constant parameters by moving the cursor and using $\boxed{6}$ $\left[\leftarrow\right]$ $\left[\rightarrow\right]$ $\left[\uparrow\right]$ $\left[\downarrow\right]$ buttons, and then press $\boxed{6}$ **ENTER** to execute the selecting item.

Notes:

- * This function can only be operated on the card remote control.
- * The selections are preferred options that will be chosen if they are available on a disc. If the disc inserted does not have the preferred option then the disc's own preference will be used.
- * Regarding SETUP MENU, please refer to the following pages for more details.
- * Some functions vary depending on the types or formats of the disc.

OPERATIONAL MANUAL

Preferences page :

[Press **SETUP**, the screen will display system setting picture as followings:]

LANGUAGE

Menu Language	> English
Disc Audio	> Original
Disc Subtitle	> Original
Disc Menu	> Original



[Press▷]

DISPLAY

TV Aspect	>16: 9
Display Mode	>widescreen
TV Output	>Auto

◆ move ▶ select



[Press▷]

AUDIO

Dolby Digital	>Bitstream
DTS	>Bitstream
Sample Freq.	>48KHz
Digital Output	>On

◆ move ▶ select



[Press▷]

LOCKED

Rating	>Unlock
Password	>****
Country Code	>US

◆ move ▶ select



[Press▷]

OTHERS

Load Default	>Select
Screen Saver	>On

◆ move ▶ select

OPERATIONAL MANUAL

[Press **SETUP**, the screen will display system setting picture as followings:]

LANGUAGE

Menu Language	> English
Disc Audio	> Original
Disc Subtitle	> Original
Disc Menu	> Original



[Press▽]

LANGUAGE

Menu Language	▶English
Disc Audio	
Disc Subtitle	
Disc Menu	

◀ prev.◆ move ▶ select



[Press▽]

LANGUAGE

Menu Language	▶Original
Disc Audio	▶English
Disc Subtitle	▶Spanish
Disc Menu	▶German
	▶Italian
	▶Portuguese
	▶French

◀ prev.◆ move ▶ select



[Press▽]

LANGUAGE

Menu Language	▶Off
Disc Audio	▶Original
Disc Subtitle	▶English
Disc Menu	▶Spanish
	▶German
	▶Italian
	▶Portuguese

◀ prev.◆ move ▶ select

Note: The same operation with the language setup.



[Press▽]

LANGUAGE

Menu Language	▶Original
Disc Audio	▶English
Disc Subtitle	▶Spanish
Disc Menu	▶German
	▶Italian
	▶Portuguese
	▶French

◀ prev.◆ move ▶ select

Note: The same operation with the language setup.

Note: The same operation with the language setup.